



**COUNTY OF LOS ANGELES  
DEPARTMENT OF AUDITOR-CONTROLLER**

KENNETH HAHN HALL OF ADMINISTRATION  
500 WEST TEMPLE STREET, ROOM 525  
LOS ANGELES, CALIFORNIA 90012-3873  
PHONE: (213) 974-8301 FAX: (213) 626-5427

WENDY L. WATANABE  
AUDITOR-CONTROLLER

MARIA M. OMS  
CHIEF DEPUTY

ASST. AUDITOR-CONTROLLERS

ROBERT A. DAVIS  
JOHN NAIMO  
JUDI E. THOMAS

April 27, 2010

TO: Supervisor Gloria Molina, Chair  
Supervisor Mark Ridley-Thomas  
Supervisor Zev Yaroslavsky  
Supervisor Don Knabe  
Supervisor Michael D. Antonovich -

FROM: Wendy L. Watanabe  
Auditor-Controller

SUBJECT: **MANAGEMENT AUDIT OF THE DEPARTMENT OF CORONER**

Attached is a management audit report on the Department of Coroner (Department or Coroner). The First and Second Supervisorial Districts and the Chief Executive Office (CEO) requested the audit because of allegations concerning the management of the Department. We hired Strategica Inc. (Consultant) to evaluate the Department's mission, operations, policies, procedures and programs to provide the basis for recommendations for improving the effectiveness and efficiency of program operations and service delivery. The audit included benchmarking and best practices analysis to evaluate specific Coroner operations and overall performance.

The Coroner's budget is approximately \$28 million and there are 209 budgeted positions in Fiscal Year 2009-10.

**Summary of Findings**

The audit report shows that Coroner employees are dedicated to the mission of the Department and produces thorough, complete and credible records of the cause and manner of death in cases that fall under the Coroner's statutory purview. The Department is also timely, responsive and well-prepared for criminal justice agencies, including law enforcement, the District Attorney, Public Defender and the courts. However, management attention is required on issues regarding workplace culture, organization structure, work processes, security, etc. These and other concerns facing the Department are discussed in more detail below and on the attached Consultant's report.

## **Human Resources Management**

### **Workplace Culture**

Surveys of employee work culture, reinforced by interview and focus group input, produced significant negative results in two divisions, Investigations and Decedent Services. Examples of these issues included employees' perception of inequities, unfair treatment, favoritism in assigning work and take home vehicles, etc. The Consultant recommends that the Department establish formal lines of communication beyond the existing chain of command structure with the Investigations and Decedent Services units to address work culture issues.

### **Physician Staffing**

The Department currently employs 24 physicians. Within the next four years, the Department is likely to experience a shortage of physicians (e.g., due to retirement, difficulty in retaining postgraduates, etc.). The shortage may result in autopsy backlogs and it may threaten the Department's ability to meet the National Association of Medical Examiners (NAME) accreditation standard of 250 autopsies annually per physician. The Coroner is undertaking some initiatives to address the impending physician shortage. For example, the Department has started exploring the use of Pathology Assistants to perform medical examinations. Pathology Assistants are less expensive than physicians and are relatively easier to recruit. The Consultant recommends that the Department:

- Work with the County Department of Human Resources to create a Pathology Assistant job classification and a competitive salary range.
- Appoint a mentoring director, establish a code of conduct on how to deal with and establish a resident mentorship program for physician postgraduates.

## **Organizational Structure**

The Coroner is the only County department that has a bifurcated management structure. The dual executive arrangement is also unique among the large coroner agencies in the nation. Although, the structure has worked well under the current leadership, the CEO/Board of Supervisors should consider consolidating the agency under a single chief executive position when the opportunity arises through retirement.

## **Work Processes**

### **Data Collection and Documentation**

Coroner cases are well documented. However, there is redundancy in the data collection process. The same data elements are collected, written down or input

multiple times resulting in process inefficiencies and excessive use of paper documents in the file than is necessary. A major cause of the inefficient processes is the use of outdated workflow technologies. The Department's case management system (i.e., CME) is primarily used as a typing tool for many documents that are then printed and put into a paper case file. CME also lacks a document management component which leads to inefficiencies in the ability to store, retrieve, share and transfer case data and ensure effective data backup. The Consultant recommends that the Coroner continue its effort to 1) implement workflow technologies using Documentum<sup>1</sup> and 2) program a replacement Case Management System in Documentum.

### **Data Backup and Archiving**

Much of the data collected and stored at the Coroner is not always backed up and major losses of data have occurred. For example, case files from 1996 were converted to digital form and the paper files were destroyed as part of the document retention procedure. Unfortunately, the media containing the digital files was rendered unreadable and all the case files from calendar year 1996 are now almost completely gone. This could potentially impact law enforcement's ability to investigate and prosecute homicide cold cases. The Consultant recommends that the Department 1) scan all archived homicide cases not yet disposed (e.g., cold cases or not yet brought to trial, etc.) and cases from the previous five years, and 2) transfer management of lab personal computers to the Internal Services Department to ensure adequate back-up.<sup>2</sup>

### **Decedent Services (Cremation)**

The Coroner is using a private cremation contractor to dispose of the bodies of indigent decedents. Prior to February 2009, the Coroner would rely on the County's crematorium (operated by the LAC+USC Medical Center Morgue) to handle the indigent decedents. County Code 2.76.080 assigns responsibility for cremating the indigent decedents of Los Angeles County to the Department of Health Services (DHS). However, in February 2009, DHS stopped taking indigent decedents from the Coroner due to DHS' own increasing caseload of decedents. Faced without a cremation option, the Coroner contracted with private cremation facilities to handle these indigent cases, which resulted in additional unbudgeted expense to the Coroner. The Consultant recommends that the CEO, in conjunction with the Coroner and DHS, review the current processes and costs of handling indigent decedents to determine 1) if appropriate County resources exist, 2) whether the processes comply with County ordinance and 3) whether options such as outsourcing the cremation function should be considered.

---

<sup>1</sup> Documentum is the new County standard for document management.

<sup>2</sup> Department management indicated that Coroner data kept on ISD servers are maintained in accordance with the County's disaster recovery plan.

### **Financial Management (DNA Testing Lab)**

Currently, the Coroner outsources its DNA testing needs to commercial labs, and in certain cases, the Department of Justice (DOJ). However, commercial labs are expensive and the use of other labs has resulted in delays (e.g., the DOJ's average turnaround time is nine months, etc.) in the identification of unidentified bodies and notification of next of kin. Department management developed a Business Plan that discusses the need for its own (in-house) DNA testing lab, including cost estimates, over a three-year period. However, the Consultant recommends that the Business Plan be revised to include reasonable demand and financial projections, including financial viability to sustain the lab beyond the three-year timeline.

### **Security**

#### **Employee Security**

Security at the Coroner needs to be improved. Work-release and community service workers who perform custodial services are not always properly supervised. Coroner employees expressed concerns for their safety while working along side these individuals. Several employees indicated during interviews that one community service worker came to work armed. According to the incident report, a handgun was found on the worker, law enforcement officials were called, and they removed the worker from the premises. The Consultant recommends that the Department 1) hire custodial staff or contract with a provider for custodial services and 2) monitor and document security incidents to determine if additional security measures should be implemented.

#### **Data Security**

The Coroner's case management system (i.e., CME) lacks a security hold feature that prevents the unauthorized release of data. Once logged on to CME, the authorized Coroner employee has access to case information, death certification information and case notes, which includes the decedent's medical data, cause of death, chronology of events, next of kin, etc. The exception to this is any case put on "security hold". Security hold cases are restricted to only a few Coroner employees and are typically used for high-profile decedents (e.g., celebrities, etc.) or cases involving ongoing police investigations. However, there are two CME "documents" (i.e., medical evidence inventory form and investigation narrative) containing potentially sensitive information about a death scene, the condition of the body, medications that were nearby, etc. that are not protected by the system's "security hold" feature. The Consultant recommends that the Department work with the vendor to correct the security hold vulnerabilities in CME.



### **Acknowledgment**

On February 4, 2010, we met with Coroner management to discuss the report. The Department concurs with most of the findings and recommendations contained in the report. The Department's detailed response (attached) indicates that management has taken a number of corrective actions to implement the recommendations.

We thank Coroner management and staff for their cooperation and assistance throughout this review.

If you have any questions, please call me or your staff may contact Jackie Guevarra at (213) 253-0198.

WLW:MMO:DR:JTG

#### Attachments

c: William T Fujioka, Chief Executive Officer  
Coroner

Anthony Hernandez, Director

Dr. Lakshmanan Sathyavagiswaran, Chief Medical Examiner-Coroner

Sachi A. Hamai, Executive Officer

Public Information Office

Audit Committee



"Enriching Lives"

**Anthony T. Hernandez**  
Director

# COUNTY OF LOS ANGELES

## DEPARTMENT OF CORONER

1104 N. MISSION RD., LOS ANGELES, CALIFORNIA 90033



**Lakshmanan Sathyavagiswaran, MD**  
Chief Medical Examiner-Coroner

April 26, 2010

TO: Wendy L. Watanabe  
Auditor Controller

FROM: Anthony T. Hernandez  
Director

Lakshmanan Sathyavagiswaran  
Chief Medical Examiner-Coroner

SUBJECT: CORONER MANAGEMENT AUDIT RESPONSE

Attached is the Coroner response to the recent management audit performed by Strategica under the oversight and direction of your office.

We wish to thank your staff for the guidance and professionalism afforded our department during this process. We also wish to thank Strategica for their efforts in conducting the audit process in a fair and accurate manner.

If you have any questions please feel free to contact me or Dr. Lakshmanan directly, or your staff may contact Sarah Ahonima at (323) 343-0784.

ath

Attachment

### Accreditations:

*National Association of Medical Examiners  
California Medical Association-Continuing Medical Education  
Accreditation Council for Graduate Medical Education*

*American Society of Crime Laboratory Directors/LAB  
Peace Officer Standards and Training Certified*

DEPARTMENT OF CORONER  
RESPONSE TO STRATEGICA MANAGEMENT AUDIT  
April 26, 2010

**Recommendation A1** - The Department of the Coroner should continue pursuing a Pathology Assistant training and residency program (e.g., with Rosalind Franklin University and the UCLA School of Medicine).

**The Coroner agrees with recommendation A1.**

The Coroner has been in negotiation with the Rosalind Franklin University for the purpose of entering into an affiliation for utilizing their Pathology Assistants for certain autopsies under the direction of the Chief Medical Examiner-Coroner. The affiliation letter is ready for Board agenda scheduling. (UCLA School of Medicine does not maintain Pathology Assistant students.)

**Recommendation A2** - The Department of the Coroner should work with the County Department of Human Resources to create a Pathology Assistant job classification and a competitive salary range.

**The Coroner agrees with recommendation A2.**

The Coroner will pursue creating a new classification with the Department of Human Resources and work to create a competitive salary.

**Recommendation A3** - The Department of the Coroner should request an appropriation to fund the on-call forensic pathologist contracts for 2,000 hours per year beginning in FY 2010-11.

**The Coroner agrees with recommendation A3.**

The Coroner has requested an appropriation increase for the physicians as-needed contract in the 2010-11 budget submission in the amount of \$500,000, roughly the equivalent of the 2,000 hours indicated in the recommendation.

**Recommendation A4** - The Department of the Coroner should appoint a mentoring director among the staff physicians and establish a code of conduct for physicians in dealing with physician postgraduates. Establish a resident mentorship program.

**The Coroner agrees with recommendation A4.**

The Coroner has appointed a mentoring director who will be developing a code of conduct for permanent physicians interacting with postgraduates.

**Recommendation A5** - The Department of the Coroner management should better communicate, monitor, and enforce criteria for promotions, recognition, and assignments to ensure they are predictable and consistent.

**The Coroner partially agrees with recommendation A5.**

The Coroner recognizes that the survey scores indicate dissatisfaction by the investigative and transport sections exclusively. However, a correlation between the low survey scores of these two groups and actual Human Resources (HR) indicators is not supported when looking at complaints, exam appeals, grievances, or other venues. The Coroner practices strict adherence to civil service rules and has a zero tolerance for disparate treatment and these issues are not indicated with the rest of the groups in the survey. Further, the Coroner consistently engages in programs and awards to recognize its employees, which includes a yearly employee appreciation breakfast, holiday gatherings, Board Scrolls, letters of appreciation, county service awards acknowledgement, 25 year employee recognition luncheon, County-sponsored events, and divisional awards programs. Nonetheless, we agree that communication can be improved to help allay fears or misperceptions of inequities.

**Recommendation A6** - The Department of the Coroner should establish formal lines of communication beyond the existing chain of command structure with these two units to address issues, perceived, or otherwise.

**The Coroner agrees with recommendation A6.**

As indicated in the response to A5, the Coroner agrees that a significant portion of these concerns are largely associated with miscommunication between Coroner management and the indicated groups. The Coroner encourages participation by the groups in question in the Departmental Health & Safety Committee, Security Committee, Efficiency Committee, Vehicle Accident Review Board, Labor Management meetings, regular Supervisor Meetings, Unit Staff Meetings, e-mail communication, and all Departmental policies and procedures are on the network shared drive easily accessed by employees. The Coroner will initiate separate meetings with these units to help address any concerns and provide accurate responses to questions or ongoing issues that the two indicated groups may have.

**Recommendation A7** - The Department of the Coroner should revise its Take-Home Car policy to clearly define eligibility for participation, a finite time-line for participation (so that other Investigators have the opportunity to participate), and the expected on-call response rate. Additionally, a process for tracking and monitoring on-call response rates should be developed to ensure compliance with Department policy and strictly followed to ensure transparency.

**The Coroner partially agrees with recommendation A7.**

Response rate is only one of several components to the criteria for participation in the Field Response Vehicle Program. The policy clearly states that management will consider quality and consistency of an employee's work product, attendance, performance evaluations (competent or better), driving history (no at fault accidents or DMV points assessed), historical availability for scheduled or unanticipated overtime, call back, after hours call outs, and geographic location of primary residence. "Rotating" these vehicle assignments could cause disruption in the program, which is currently working efficiently and we are unaware of any Public Safety agency that rotates their field response vehicles as recommended. Further, the Grand Jury has recognized the Coroner's Field Response Vehicle Policy as a model in its review of the County's Assigned Vehicle Program. While there were only two low responders in the review, current records do not account for participants who are on special assignment such as training, Special Operations Response Team (SORT), Homeland Security assignments, vacation, etc. which has the affect of altering an individual's response rate. Additionally, the statistics used do not include early starts or late calls handled. Accordingly, the Coroner agrees that enhanced tracking of the participant response rate will help improve assessment of each employee's compliance with the program criteria.

**Recommendation B1** - When the opportunity arises through retirement, the CEO/Board of Supervisors should consider consolidating the agency under a single chief executive position. Unifying command of the agency under a single position is inherently more efficient and eliminates the effect of personality on the effectiveness (or lack thereof) of the management structure.

**The Coroner partially agrees with recommendation B1.**

While the Chief Medical Examiner-Coroner favors the single executive system, he and the Director agree on the following:

In 1990 the Board of Supervisors took the action of bifurcating the Coroner management structure to accomplish an important objective; to alleviate the Chief Medical Examiner-Coroner (CME-C) of the rigors of administering one of the largest operations in the nation under one roof thereby freeing the CME-C to carry out statutory Coroner functions, focus on improving the agency's ability to accurately determine cause and manner of death, and set medical standards to improve the quality and professionalism of the office. Under the bifurcation, this objective has been met and exceeded, with the Coroner making significant improvements over the years, which includes full accreditation in all scientific disciplines (rare for a department of this size), operational improvements resulting in effective and responsive service to families, outside agencies, and the criminal justice system, as well as financial budgetary stability supported by the Board and the CEO. As indicated in the Accomplishments Section of the audit (Page 13), this stability did not come into being until the implementation of the bifurcation allowing each department head to focus on their delineated



## **B1 partially agrees continued**

responsibilities, free from areas of responsibility, not specific to their specialties. (The current Chief Medical Examiner-Coroner and Director were appointed in 1992 and 1994 respectively) The Coroner believes that this bifurcated system has significantly improved the professionalism, scientific capabilities, and quality of the operations, which can continue to thrive beyond the current tenure of the existing two executives.

**Recommendation B2** – The Department of the Coroner should transfer the oversight responsibilities of the Forensic Photo and Support Division to the Chief Medical Examiner-Coroner.

## **The Coroner partially agrees with recommendation B2.**

While the Chief Medical Examiner-Coroner is neutral on the transfer, he and the Director agree on the following:

Currently, the Forensic Support Unit reports to the Operations Bureau. Operations Bureau maintains the appropriate management oversight and disciplinary control of this unit, which is supported by Administration. The current configuration is working effectively and efficiently with no issues raised in the audit. There have been no significant problems with management or supervision of personnel or day-to-day operational issues beyond that, which is normal for such an operation. Changing the oversight will not improve those areas. We have concerns that moving Forensic Support under the Forensic Medicine Bureau may in fact compromise the existing working structure because it will require adding these additional responsibilities to our Forensic Pathologists who are intensely focused on determining cause and manner of death, evaluating the physical aspects of Coroner autopsy examinations, as well as preparing for and testifying in court. This is especially true in light of the Melendez-Diaz ruling, which gives defendants the right to question authors of reports, which has the effect of calling pathologists, investigators, criminalists, lab techs, etc. to testify in lieu of a substitute, or stipulation to the record. The current organizational structure allows the medical professionals to focus on their primary role, while the responsibility of supporting that role rests with those best equipped to handle the critical needs associated with the daily operational support of the autopsy service.

**Recommendation C1** – The Department of the Coroner should continue its efforts to implement workflow technologies using a case management system and the County's planned Documentum<sup>1</sup> document management system to replace the reliance on paper case files and inefficient document preparation and transfer practices.

---

<sup>1</sup> A document management system produced by EMC. This system is described later in the report.

**The Coroner agrees with recommendation C1.**

Prior to the audit, the Coroner collaborated with both the Internal Services Department/Information Technology (ISD/IT) and the Chief Information Office (CIO) to initiate implementation of the County-approved EMC Documentum document management system, which will serve as the department's platform to initiate a paperless case file system and replace our aging (10 year old) case tracking system (CME) with a Case Management Tracking System. Since that time, an Information Technology Fund (ITF) grant has been procured to design and implement an EMC Documentum document management, which is nearly complete. The Coroner is working with ISD to develop requirements for a new Case Management Tracking System. Ongoing maintenance costs have been incorporated into the 2010-11 net county cost budget. However, additional funds in the amount of \$250,000 will be necessary to implement the Case Management Tracking System, which has been requested in the Department's 2010-11 fiscal year budget.

**Recommendation C2** – The Department of the Coroner should test touchpad-based data collection tools (e.g., laptops or other field recording devices) for medical examiners and investigators.

**The Coroner agrees with recommendation C2.**

The Coroner has tested laptops with the intent of collecting and sharing data in the field. However, the main database for collection and sharing is CME. As mentioned in the C1 response CME is 10 years old and is unable to connect with today's technology from the field. Among other objectives, connectivity from the field is a primary consideration with the implementation of the Documentum platform and case tracking replacement. Once the implementation is complete, the Coroner will be able to establish connectivity from the field. In the interim, medical examiners, and investigators (as do most employees) have access to desk tops to perform duties and functions, including accessing the CME database.

**Recommendation C3** – The Department of the Coroner should implement barcode labeling for all bodies, materials, specimens, samples and documents. If possible, it should use the Documentum system to produce labels based on case numbers generated in the case management system.

**The Coroner agrees with recommendation C3.**

The Coroner has tested barcoding for mainly body tracking in the past. However, the technology at the time did not fare well in the moist/cold environment of the crypts and bar code inks tended to run when in contact with fluids. We recognize that the newer technology will fare much better in this environment and we are currently submitting proposals for federal grants in this area. Barcoding will also be considered with the implementation of Documentum as indicated in the C3 recommendation.

**Recommendation C4** – The Department of the Coroner should replace the MS-Access-based Tox database with a toxicology lab module integrated into the case management system.

**The Coroner agrees with recommendation C4.**

The Coroner has made several attempts toward integrating the Toxicology (Tox) database into CME's case management system. Each time lack of flexibility with CME prevented these efforts from moving forward. The Coroner will initiate this recommendation upon the implementation of Documentum and the new Case Tracking System.

**Recommendation C5** – The Department of the Coroner should continue its efforts to finalize the implementation of the Documentum platform and electronic case files. Once in place, the Coroner should continue its plan to implement a replacement Case Management System in Documentum.

**The Coroner agrees with recommendation C5.**

(This response is similar to the response to recommendation C1 above)

Prior to the audit, the Coroner collaborated with both ISD/IT and the CIO to implement the County-approved Documentum, which will serve as the Department's platform to initiate a paperless case file system and replace our aging (10 year old) case tracking system (CME) with a Case Management Tracking System. Since that time, an ITF grant has been procured to design and implement a Documentum-based document management system, which is nearly complete and ISD is developing requirements for the Case Management Tracking System. Ongoing maintenance costs have been incorporated into the 2010-11 net county cost budget. However, additional funds in the amount of \$250,000 will be necessary to implement the case management system, which has been requested in the Department's 2010-11 fiscal year budget.

**Recommendation C6** – The CEO, in conjunction with the Coroner and DHS, should review the current DHS/Coroner processes and costs of handling the indigent dead to determine if appropriate resources, staffing, equipment, infrastructure (facilities, crematories) exist to adequately meet the needs of all County indigent decedent cases in a cost-effective manner, whether the process complies with existing County ordinance, and whether other options such as outsourcing should be considered.

**The Coroner agrees with recommendation C6.**

As indicated in the audit report, the Coroner has a mandated public safety mission to determine cause and manner of death, identify the deceased and notify the legal next of kin. The Coroner must have appropriate refrigerated facilities to carry out this mission which includes the ability to store, investigate and examine cases, secure evidence for law enforcement and the courts, and have sufficient flexibility to handle surges in caseload that occur from mass fatality incidents such as airline disasters, earthquakes, ground transportation disasters, and unpredictable caseload spikes as experienced in the 2007 heat wave, which increased the decedent population in the crypts to 477. Any one of these scenarios can quickly fill or exceed the proposed new crypt capacity of 525. As indicated in the report there are several reasons why the caseload has leveled. In 2007 a reopening of the LAC+USC Morgue's cremation services and streamlined handling of long term cases by the Coroner helped resolve the overcrowding. However, in present conditions LAC+USC Morgue's cremation services have been closed to us permanently since February of 2009, which has forced the Coroner to seek private contracting as a means to handle indigent and unclaimed decedents that are handled through the Coroner (the Coroner has no capabilities or infrastructure to conduct cremations). This initially created an unanticipated burden to the Coroner's budget which was already critically depleted due to ongoing curtailments. We estimate that of all the indigent and unclaimed dead handled by the County, approximately one third of this population requires handling by the Coroner for jurisdictional purposes such as determining cause of death, identification, and next of kin notification. The remaining two thirds have no public safety jurisdiction for the Coroner. By Board Ordinance *all* indigent and unclaimed dead are to be handled by the LAC+USC Morgue (DHS) for cremation, including the indigent cases that are initially handled by the Coroner. Given the economic conditions, more families find themselves in a position of needing the services of the County LAC+USC Morgue as the last resort for handling the remains of a loved one or that of a decedent who goes unclaimed by their family. Similarly, the Coroner is dependent on this resource to provide cremation services for the indigent and unclaimed cases handled by the Coroner in a manner that avoids caseload backlogs through timely service and does not create impediments, which undermine the effectiveness of the system.

**Recommendation C7** – The Department of the Coroner should scan all archived homicide cases that have not been disposed of (e.g., cold cases or not yet brought to trial), and cases from the previous five years starting with the most recent year.

**The Coroner agrees with recommendation C7.**

The Coroner will create a list of all available homicide cases and initiate scanning starting with current cases. Presently, the Coroner is near completion of scanning 1997 regular cases and once 1997 is complete, the Coroner will start scanning regular cases going back five years, starting with the most recent year in compliance with the

## **C7 agrees response continued**

recommendation. As indicated in the report, losses of 1996 cases occurred due to compromised or corrupted digital media, which was purchased nearly 15 years ago. At the time the Coroner was not on a shared network, as we are today, making back-up to ISD difficult. In recent years, the Coroner entered into shared IT services with ISD which allows seamless backing of cases to ISD servers. Significant recovery efforts utilizing the assistance of ISD, CIO, and outside recovery contractors were initiated with limited results. As indicated in the report, the Coroner has the ability to recreate files through other means should they be required for any reason. Thus far, there have been no issues associated with these cases. Similar efforts were undertaken with the compromised photographs with much better recovery results. As indicated in the report, additional photographs from law enforcement are available should they be needed.

**Recommendation C8** - The Department of the Coroner should transfer management of lab PCs to ISD to ensure adequate back-up.

### **The Coroner agrees with recommendation C8.**

The Coroner will transfer the management of the lab PCs to ISD as soon as possible utilizing ISD's IT shared services. In order to do this, lab equipment and PC's must be upgraded to current versions/standards. (Costs will be developed) The Coroner will also make plans to assimilate toxicology test data into a new case tracking system following the implementation of the Documentum platform.

**Recommendation C9** - The Department of the Coroner should use digital dictation equipment for recording medical exam observations. In the longer term, the department should phase out making corrections onto paper and begin correcting dictations directly onto MS-Word utilizing the track changes feature.

### **The Coroner agrees with recommendation C9.**

The Coroner will develop a cost estimate to replace all antiquated analog dictating equipment utilized by physicians and transcribers with current digital equipment and present it to the CEO for consideration. In the meantime, the Coroner has implemented the use of MS-Word on the back-end for making corrections to the documents, once they have been transcribed from the analog media. Once the digital equipment is procured, the digital dictation can be initiated and uploaded to MS-Word on the front-end completing the digital loop, which further limits the use of paper while increasing efficiency.

**Recommendation C10** - The Department of the Coroner should use appropriate size jars for tissue sampling in accordance with standards set by the College of American Pathologists.



**The Coroner agrees with recommendation C10.**

The College of American Pathologist (CAP) standard requires an appropriate ratio of formalin (fixative) to tissue, to ensure proper fixation. One way to achieve this ratio is to use as large a container as necessary for the amount of tissue submitted. However, this may also be achieved more economically and efficiently by utilizing more than one stock jar to accommodate the amount of tissue collected. For example, the Coroner would discourage the use of large jars if the sample collected was minimal. This is an essential consideration when storage space for tissue samples is at a premium. Some medical examiners may not be fully aware of this availability, which will be communicated at the next medical examiner business meeting.

**Recommendation C11** – The Department of the Coroner should enforce policies on wearing protective gear in the autopsy suites.

**The Coroner agrees with recommendation C11.**

The Coroner has addressed this issue by enhancing the autopsy floor wearing apparel policy, which now includes a component for disciplinary action for violations of the policy which will be fully enforced.

**Recommendation C12** – The Department of the Coroner should implement routine quality control checks of Investigator evidence and property submissions by persons outside the Investigator chain of command. The Evidence Control Supervisor and the Property Supervisor could then meet with Investigations management to go over recent problem cases and suggest corrections.

**The Coroner agrees with recommendation C12.**

Quality control checks of Investigator evidence and property are already in place, conducted by the Laboratory Evidence Control Supervisor and the Public Services Property Supervisor both of which are outside of the Investigator chain of command. The Coroner will take steps to formalize the meetings with Investigations management to complete the remainder of the recommendation.

**Recommendation C13** – The Department of the Coroner should send generic letters to the next of kin 30 days after notification of death is first made, in addition to the courtesy letters that are sent months later if property has not been claimed. This initial notification letter should inform the next of kin regarding procedures for claiming property and retention and disposal policies.

**The Coroner agrees with recommendation C13.**

The Coroner has already implemented this recommendation ensuring that property letters to next of kin are sent out within 30 days of death notification.

**Recommendation C14** – The Department of the Coroner should develop an equipment replacement plan for labs and autopsy areas.

**The Coroner agrees with recommendation C14.**

The Coroner is currently assessing the Laboratory and autopsy equipment for the purpose of scheduled replacement. The plan will be finalized within the next 30 days and submitted to the CEO for funding consideration.

**Recommendation D1** – The Department of the Coroner and the CEO should consider modifying the renovation plan to include offices for all physicians that comply with County space standards published by the CEO, if they have not yet been renovated.

**The Coroner agrees with recommendation D1.**

The portion of the renovation plan which encompasses refurbishment and new construction of the physician office space has already been completed. All physicians have been allocated offices and are partially moved in. Newly constructed offices meet the county standard as do most of the renovated offices. However, lack of space prevents achieving the standard for 100% of the offices.

**Recommendation D2** - The Department of the Coroner should obtain approval from the CEO to modify the renovation plan to include renovation of the 1102 building, including new ceilings, floors, and furnishings.

**The Coroner agrees with recommendation D2.**

The Coroner will submit an official request to the CEO to consider a modification to the renovation plan that includes renovation of the 1102 building.

**Recommendation E1** – The Department of the Coroner should recalculate the GSR testing fee to ensure it accurately reflects actual costs on a per-test basis.

**The Coroner agrees with recommendation E1.**

The Gun Shot Residue (GSR) testing fees have been recalculated and approved by the Auditor Controller.

**Recommendation E2** – The Department of the Coroner should pursue an amendment to County Code section 2.22.100 so that the actual expense incurred for transportation and handling can be recovered through fees.

**The Coroner agrees with recommendation E2.**

County ordinance currently limits this fee to \$200 per case. The Coroner will prepare a letter to the Board requesting an amendment to the code section to increase the fee to recover actual costs.

**Recommendation E3** – The Department of the Coroner should license the manufacture and sale of Skeletons merchandise to an outside firm and/or relocate to a high-traffic area (preferably one with tourists).<sup>2</sup> Combine with merchandise from other County and City agencies to reflect the colorful history of LA County government, one of the world’s most fascinating urban areas.<sup>3</sup>

**The Coroner agrees with recommendation E3.**

The Coroner is open to licensing the manufacture and sale of Skeletons merchandise to outside firms as well as outside locations. As a matter of fact, several licensing agreements have been let in the past history of the store with positive initial results, but the sustainability of these ventures has been less than optimal. In addition to considering potential licensing agreements, the Coroner plans to aggressively pursue marketing the store in the high traffic areas of the web. As stated in the report, Skeletons maintains a website which incorporates the ability to purchase items online, but the website is somewhat shielded from potential buyers due to lack of marketing/advertising in highly visited areas such as Youtube, Facebook, and other related social websites. In order for a product to sell it must have visibility and attract interest of the potential buyer; therefore, a reasonable investment into this type of advertising for increasing sales makes sense. The Skeletons store has placed a positive public relations face on the Coroner as well as the County, and many look to our merchandising products not just as gifts, but also for use in promoting positive events through displays, presentations, and auctions. Skeletons is also one of the first entities to introduce online purchasing for the County, which has opened the door for many transactions involving electronic payment and collections throughout the County. This has also established a gateway for a series of new capabilities, which will include the online purchasing of documents such as autopsy reports, investigator reports, fees for Coroner provided training, statistical data, and other revenue generating documents. This platform will eventually expand to include online payment for a variety of different Coroner services such as Gun Shot Residue Testing (GSR), Outside Agency Case Identifications, Witness Fees, Histopathology Requests, Document Sales, and online payment for Youthful Drunk Driving Visitation Program (YDDVP) participation all of which will improve the revenue collection capabilities of the Coroner.

---

<sup>2</sup> Favorable locations may include the international terminal at LAX, Hollywood Boulevard, or the Melrose District.

<sup>3</sup> During the project, the auditors viewed an interesting exhibit on the history of the County District Attorney installed in the Criminal Courts Building. This type of history could also be merchandised and sold along with the Coroner merchandise in a way that captures the rich history of Los Angeles County government.

**Recommendation E4** – The Department of the Coroner should age accounts receivable on a monthly basis to identify those outstanding for over 30, 60 and 90 days and to ensure future services are not rendered (except those mandated by legal authority) until past due amounts are paid.

**The Coroner partially agrees with recommendation E4.**

With the exception of Transportation and Storage (T&S) and Veterans burials, the Auditor Controller ages accounts receivable for the Coroner through their shared services. The majority of outstanding receivables are T&S and government related services. T&S incorporates a third party collection system (mortuaries collect fees on behalf of the Coroner) that will be turned back over to the Coroner, but this is also a mandated function for which services cannot be withheld. The remainder of the outstanding receivables are services rendered to government agencies. Government agencies have more complex billing and payment systems which will result in an outstanding receivable. However, all billed government agencies pay once the payment process has been finalized by the agency.

**Recommendation E5** – The Department of the Coroner should require a retainer or payment up front for clients who demonstrate a history of non-payment or slow payment. This would apply primarily to law firms that pay for Coroner testimony.

**The Coroner partially agrees with recommendation E5.**

Law firms that pay for Coroner testimony do not typically have a history of non-payment. In fact, a retainer from these firms is required prior to the services being rendered. The majority of the accounts showing to be delinquent on the receivables chart are for T&S and government services for which payment up front could not be required.

**Recommendation E6** – The Department of the Coroner should refer delinquent accounts (except for receivables from municipalities) to the TTC for collections per County Fiscal Manual Section 10.2.2 guidelines.

**The Coroner agrees with recommendation E6.**

As indicated in E4, the Auditor Controller refers delinquent accounts to TTC through their shared services agreement with the Coroner. T&S delinquent accounts are now being referred to TTC.

**Recommendation E7** – The Department of the Coroner should work with the CEO to ensure that the DNA Lab Business Plan includes reasonable demand and financial projections, including financial viability to sustain the lab beyond the three year timeline.

**The Coroner agrees with recommendation E7.**

The Coroner has updated its Business Plan to address demand, financial projections, and viability to sustain the lab beyond the three year timeline. The Coroner will work closely with the CEO to ensure that the DNA Lab project will achieve its intended objectives.

**Recommendation F1** - The Department of the Coroner should enforce a strict ID badge policy for employees.

**The Coroner agrees with recommendation F1.**

The Coroner maintains an ongoing Security Committee, which meets regularly to address issues of security. The Security Committee has recently revised the Coroner's Security Policy as one of their many objectives, which specifically addresses the enforcement of ID badges throughout the department.

**Recommendation F2** - The Department of the Coroner should install an up-to-date electronic card key access system in all buildings.

**The Coroner agrees with recommendation F2.**

The Coroner has included an estimate to the CEO to consider replacing the existing key system with a card key system in the 2010-11 fiscal year budget.

**Recommendation F3** - The Department of the Coroner should hire custodial staff or contract with a provider of custodial service and eliminate the use of community service and work-release workers to perform custodial duties.

**The Coroner agrees with recommendation F3.**

The Coroner has submitted an estimate to the CEO for consideration of expanding the existing custodial services cleaning contract thereby eliminating the use of community service and work-release workers for the 2010-11 fiscal year budget.

**Recommendation F4** - The Department of the Coroner should judiciously monitor and document security incidents for a period of two years and analyze the findings to determine what, if any, additional security measures should be implemented to ensure a safe working environment for Coroner staff.



**The Coroner agrees with recommendation F4.**

The Coroner already complies with the appropriate policies and procedures for reporting security incidents to the appropriate entities. The Coroner will increase its monitoring of reported incidents to determine if additional security measures should be implemented.

**Recommendation F5** – The Department of the Coroner should obtain a qualified trainer to help modify the dog’s temperament and evaluate and develop handling and care procedures (e.g., socialization, leash and boarding requirements, ect.). If incidents such as attacks and bites continue after the dog receives behavioral training, consider kenneling the dog at an offsite location during the day.

**The Coroner agrees with recommendation F5.**

The Cadaver Dog has received and continues to receive program required training which includes socialization. The Cadaver Dog handler works closely with an industry recognized training agency and other canine handlers to continually improve the Coroner Cadaver Dog program. It is through these efforts that incidents have been managed to zero within the last year. To further enhance the program and safety of the canine resource, the department is in the process of finalizing a kennel facility adjacent to the building, where the Cadaver Dog will be housed while on the Coroner grounds. The kennel will be readily accessible to the handler, which will provide a safe and secure environment for the canine and further ensure the viability of this important resource program.

**Recommendation F6** – As indicated in Recommendation C5, the Coroner should continue its plans to implement a replacement Case Management System in Documentum. In the interim, the Department of the Coroner should continue working with a private vendor to correct the Security Hold vulnerabilities in CME.

**Recommendation F7** – As indicated in Recommendation C5, the Coroner should continue its plans to implement a replacement Case Management System in Documentum. In the interim, the Department of the Coroner should work with a private vendor to implement record-level security in CME so that only the author of a record can alter data.

**The Coroner agrees with both recommendations F6 and F7.**

(This response is partially similar to the response to recommendation C1 above)

Prior to the audit, the Coroner collaborated with both ISD/IT and the CIO to initiate the implementation of the County approved Documentum document management system

## **F6 and F7 agrees response continued**

which will serve as the Department's platform to initiate a paperless case file system and replace our aging (10 year old) case tracking system (CME) with a Case Management Tracking System. Since that time, an ITF grant has been procured to design and implement a Documentum system, which is nearly complete and ISD is developing requirements for the Case Management Tracking System. Ongoing maintenance costs have been incorporated into the 2010-11 net county cost budget. However, additional funds in the amount of \$250,000 will be necessary to implement the case management system, which has been requested in the Department's 2010-11 fiscal year budget. Further, the Coroner will formalize its efforts to make modifications to the existing CME with the intent of addressing security hold issues and case note vulnerabilities. However, the vendor has indicated that with the system being 10 years old, not web-based, and difficulty locating source codes, the prospect of serviceability and support are questionable. Nonetheless the Coroner will reinstitute its efforts to address the existing security vulnerabilities with the vendor.

**Recommendation F8** - The Department of the Coroner should replace the MS-Access-based Tox database with a toxicology lab module that is integrated into the case management system.

### **The Coroner agrees with recommendation F8.**

As indicated in C4, the Coroner will initiate this recommendation upon the implementation of Documentum and approval of the new Case Tracking System.

**Recommendation G1** - The Department of the Coroner should prioritize goals to allocate resources more effectively. Goals should be analyzed in terms of importance and ease and/or cost of implementation. For example, goals can be plotted on a graph to understand the trade-offs between importance and cost (see figure G1).

### **The Coroner partially agrees with recommendation G1.**

All goals are prioritized through the Management and Appraisal and Performance Plan (MAPP) process. As with the performance evaluation process, MAPP provides tracking and feedback of goals and accomplishments. The Department's Strategic Plan is integrated with MAPP goals, which strongly support each other. Over the years, the Coroner has had strong successes in accomplishing goals which are prioritized and tied into the Coroner Strategic Plan. The successful outcome in each of these areas is largely attributed to ongoing Strategic Planning meetings, Bureau Chief meetings, and unit meetings, which serve to consistently communicate the objectives of the Department.

**Recommendation G2** - The Department of the Coroner should prepare Action Plans for each goal, detailing timeframes and due dates, assigning accountability, describing standards, and defining specific measurements.

**The Coroner partially agrees with recommendation G2.**

As indicated in G1 MAPP goals are the action plans, which incorporate goals and objectives. Each manager is responsible for specific aspects of a goal which includes the above components and measures the outcomes. The Coroner has been successful in achieving its stated goals.

**Recommendation G3** - The Department of the Coroner should track progress of plan implementation with detailed accountability at the appropriate management or supervisor levels below the bureau chief.

**The Coroner agrees with recommendation G3.**

While the Coroner maintains a consistent record of successfully accomplishing its goals, better communication to lower levels of supervision can be beneficial. However, this has not hindered the progress of goal implementation.

title

# **Management Audit of the Los Angeles County Coroner**

submitted to

**Los Angeles County Auditor-Controller**

Report date

**April 22, 2010**



*Law and Science  
Serving the  
Community*

Management Auditing  
Process improvement  
Strategic planning  
Performance measurement  
Financial analysis  
Organizational design



[strategica-usa.com](http://strategica-usa.com)

This page intentionally left blank.





704 228<sup>th</sup> Ave NE #415  
Sammamish, WA 98074  
Tel: (425) 427-5269  
[www.strategica-usa.com](http://www.strategica-usa.com)

April 22, 2010

Ms. Wendy Watanabe  
Los Angeles County Auditor Controller  
500 West Temple Street, Room 525  
Los Angeles, CA 90012

Dear Ms. Watanabe:

Pursuant to our Work Order No. 7-68A, we have completed our Management Audit of the Los Angeles Coroner. This report contains our findings and recommendations as specified in the Work Order.

Thank you for giving Strategica, Inc. the opportunity to conduct this project. We greatly enjoyed working with you and the Coroner staff. In particular I'd like to recognize Karen Fee of the Auditor Controller staff for her many hours of hard work on the project and Sarah Ahonima of the Coroner staff for her work as our project liaison. Their assistance was greatly appreciated.

Please call on Strategica, Inc. again should you need the services of a consultant. If you have any questions or comments, please contact me at (425) 427-5269.

Yours truly,

A handwritten signature in black ink, appearing to read "David M. Howe".

David M. Howe  
President

This page intentionally left blank.

# Table of Contents

---

- Executive Summary..... 1
- Introduction
  - Description of the Coroner ..... 9
  - Accomplishments ..... 12
  - Project Objectives/Scope ..... 14
  - Standards Used ..... 14
  - Methods Used ..... 14
- FINDINGS AND RECOMMENDATIONS
  - Section A – Human resource management ..... 18
  - Section B – Organizational structure ..... 33
  - Section C – Work processes
    - Data collection and documentation ..... 38
    - Case management system ..... 42
    - Decedent Services ..... 45
    - Data backup and archiving ..... 48
    - Medical exam protocols ..... 51
    - Evidence and property custody ..... 53
    - Laboratory services ..... 56
  - Section D – Facilities ..... 57
  - Section E – Financial management ..... 61
  - Section F – Security ..... 72
  - Section G – Strategic management ..... 79
- APPENDICES
  - Appendix A – Glossary of acronyms ..... 83
  - Appendix B – Physician staffing projections ..... 84
  - Appendix C – Process maps ..... 85
  - Appendix D – Benchmarking charts ..... 93
  - Appendix E – Recommendation table ..... 97

This page intentionally left blank.

## ***Executive Summary***

### **Background**

The Department of the Coroner (The Department) is mandated by law to inquire into and determine the circumstances, manner, and cause of all violent, sudden, or unusual deaths occurring within Los Angeles County, including all homicides, suicides, accidental deaths, and natural deaths where the decedent has not seen a physician within 20 days prior to death. Statutory authority for the Coroner is derived from the California Government Code (e.g., 27491) and the Health & Safety, Penal, Vehicle and Evidence codes.

The Department is managed by two key executives: a Director who oversees non-medical functions, and a Chief Medical Examiner-Coroner who carries out statutory Coroner functions, oversees the medical functions, all the physicians, and consultants. The Department operates with a budget of \$28 million and 209 positions (per FY 09/10 budget). Staff are mostly based out of the Mission Road facility with some investigations staff out-stationed in South Los Angeles, Antelope Valley and the San Fernando Valley.

### **Overall Assessment**

The objective of this project is to evaluate the mission, operations, policies, procedures and programs of the Coroner to provide the basis for recommendations for improving the effectiveness and efficiency of program operations and service delivery. The audit included a review of all significant areas of Coroner operations including all those specified in the Statement of Work.

For most of the past half-century, the Coroner has been a model forensic science institution in the nation helping to set standards across the industry. We found

that Coroner employees were dedicated to the mission of the agency and produced a thorough, complete and credible record of the cause and manner of death in cases that fell under the Coroner's statutory purview. The agency has held up this tradition despite the limitations of available funding and an infrastructure that has not been materially updated in 30 years. Some serious issues from the past have been corrected such as crypt overcrowding, excessive workloads and property custody control issues. However, new issues have emerged over time that now call for the attention of management and County policy makers.

## **Summary of Key Findings and Recommendations**

### Human Resources Management

#### **Workplace Culture**

Employee work culture survey results show that the Investigations and the Decedent Services Divisions demonstrate negative survey scores. Many of the problems center on issues related to a perception of inequities or unfair treatment in the workplace. Reported examples of this include demeaning remarks, assignment of take-home vehicles, favoritism in job assignments and in training. While work performance and turnover do not appear to be negatively affected, the low survey scores do signal a need for more consistent application of HR policies and more open communication lines between these two units and management. To address this issue, we recommend that:

- The Department of the Coroner management should better communicate, monitor and enforce criteria for promotions, recognition, and assignments to ensure they are predictable and consistent.



- The Department of the Coroner establish formal lines of communication beyond the existing chain of command structure with these two units to address issues, perceived or otherwise.

### **Physician Staffing**

The Department currently employs 24 physicians in the Forensic Medicine Division, an adequate complement of physicians. In the future, the agency is likely to experience a severe shortage of physicians that would threaten the agency's accreditation and result in autopsy backlogs. This projected shortage of physicians is due to two key reasons: 1) the staff of physicians is aging

and many are nearing the typical retirement age of the classification, and 2) in recent years the agency has not been able to retain postgraduates once they have finished their fellowships.

Retention rates for residents are influenced by a variety of factors including postgraduates moving out of the area or accepting better job offers, and in some cases non acceptance by the Coroner. Ineffective mentoring and discouraging remarks from senior physicians is also a factor. A more formalized mentoring process for residents as well as continued efforts at improving unattractive and outmoded facilities are factors that can improve retention. We recommend that:

- The Department of the Coroner should continue pursuing a Pathology Assistant training and residency program (e.g., with Rosalind Franklin University and the UCLA School of Medicine). The Department should work with the County Department of Human Resources to create a Pathology Assistant job classification and a competitive salary range.

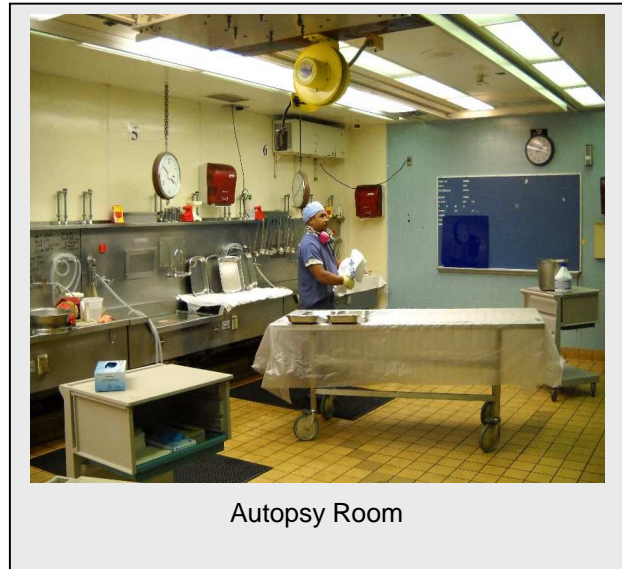

- The Department of the Coroner should appoint a mentoring director among the staff physicians and establish a code of conduct for physicians in dealing with physician postgraduates. Establish a resident mentorship program.
- The Department of the Coroner should request an appropriation to fund the on-call forensic pathologist contracts for 2,000 hours per year beginning in FY 2010-11.

## Organizational Structure

### **Dual Executive Management**

A unique feature of the current organizational structure is that there are two executives:

1. A Director who oversees the Operations, Administration and Forensic Lab Bureaus.
2. A Chief Medical Examiner-Coroner who oversees the Forensic Medicine unit and carries out statutory Coroner functions.



This dual executive arrangement is unique among the large coroner agencies in the nation and originates from a 1990 Board of Supervisors ordinance intended to improve the operations of the office. As noted in the accomplishments section of this report the bifurcated arrangement has proven successful resulting in many improvements since its inception, including full program accreditation and strong budget control. While this dual executive arrangement results in a bifurcation of command for the entire agency, accountability under the two incumbents does not

appear to be problematic. However, dual executive structures can be inherently costly due to the additional executive position. The dual management structure is effective for now for a number of reasons, including the working relationship of the two individuals involved. Although the Department has had a good track record with the present structure in place, this may change with new personnel in those positions. We recommend that:

- When the opportunity arises through retirement, the CEO/Board of Supervisors should consider consolidating the agency under a single chief executive position. Unifying command of the agency under a single position is inherently more efficient and eliminates the effect of personality on the effectiveness (or lack thereof) of the management structure

### **Division Reorganization**

The Forensic Photo and Support Division reports through the Operations Bureau, but works mostly with the Forensic Medicine Division. These two units are located in the same building and work almost exclusively with each other but separating these two units organizationally does not reflect the level of coordination that occurs between the units. We recommend that:

- The Department of the Coroner should transfer the oversight responsibilities of the Forensic Photo and Support Division to the Chief Medical Examiner-Coroner.

## Work Processes

### **Data Collection and Documentation/Case Management System**

Coroner cases are well documented. However, we noted redundancy in the data collection processes. The same data elements are collected, written down or input

multiple times resulting in process inefficiencies and excessive use of paper documents in the file than is necessary. Data collection is also very reliant on paper forms and obsolete multi-part forms. We also observed the use of obsolete systems for labeling samples, specimens, evidence and property. A major cause of the inefficient processes is the use of outdated workflow technologies. Currently the Coroner uses CME, which is a Case Management System capable of managing information on death investigations, cause and manner of death, evidence collected at scene, etc. The Department's CME System is primarily used as a typing tool for many documents that are then printed and put into a paper case file. In addition, some major parts of the organization, such as the toxicology lab, have never adapted to CME. The toxicology lab developed and uses its own MS-Access database for lab test requests and results. CME also lacks a document management component. We recommend that:

- The Department of the Coroner should continue with their efforts to implement workflow technologies using a case management system and the planned Documentum<sup>1</sup> document management system to replace the County's reliance on paper case files and inefficient document preparation and transfer practices.
- The Department of the Coroner should replace the MS-Access-based Tox database with a toxicology lab module integrated into the case management system.
- The Department of the Coroner should continue its efforts to finalize the implementation of the Documentum platform and electronic case files. Once in place, the Coroner should continue its plan to implement a replacement Case Management System in Documentum. .

---

<sup>1</sup> Documentum is a new County standard for document management and is developed, marketed and supported by EMC Corporation.

## **Data Backup and Archiving**

Major losses of data have occurred. For example, case files from 1996 were converted to digital form and the paper files were destroyed as part of a document retention procedure. Unfortunately, the media containing the digital files was rendered unreadable and all the case files from that year are now almost completely gone. This could be an issue if a cold homicide case from 1996 is reopened and case notes and findings are needed for prosecution.

Many, if not most, of the case files are never viewed or queried once the final cause of death is determined. Queries that are received usually occur during the first five years after death. Since most files are in paper form, an outdated process (see Appendix C, Law Enforcement Document Request) has been built up to fulfill requests from external parties (mostly law enforcement) for files. Storing case files in digital form would greatly expedite these requests. We recommend that:

- The Department of the Coroner should scan all archived homicide cases that have not been disposed of (e.g., cold cases or not yet brought to trial), and cases from the previous five years starting with the most recent year.

## **Employee Security**

Safety and security at the Coroner is important for many reasons including:

- Confidentiality of Coroner records has to be protected until the information becomes part of the public record,
- Evidence used for criminal investigations needs to be safeguarded,
- Coroner employees need to have a safe work environment protected from members of the public in the field or who come to the Coroner's Office and may be upset and potentially pose a threat.

The Department has implemented security measures in response to these needs. However, our observations showed:

- Policies requiring constant, physical supervision of community service and work-release workers who perform janitorial services are not fully enforced despite Work Release and Community Based Alternatives to Custody (CBAC) and Court Referred Volunteer (CRV) program policies that explicitly state that “supervision MUST be provided at all times.” Coroner employees expressed concerns for their safety while working along side these individuals. Several employees indicated during interviews that one community service worker came to work armed. According to the incident report, a handgun was found on the worker, law enforcement officials were called and they removed the individual from the premises, and
- Numerous incidents involving threats to Coroner staff (i.e., by members of the public) were recounted in interviews, focus group feedback and in phone calls to the audit team. However, many of these incidents were not documented in formal incident reports. A better documentary record of incidents where the security of Coroner staff was compromised would provide management and County policy makers with the necessary support for making decisions on enhancing security and protection for Coroner staff.

We recommend that:

- The Department of the Coroner should hire custodial staff or contract with a provider of custodial service and eliminate the use of community service and work-release workers to perform custodial duties.
- The Department of the Coroner should judiciously monitor and document security incidents for a period of two years and analyze the findings to determine what, if any, additional security measures should be implemented to ensure a safe working environment for Coroner staff.



## **Introduction**

### **Description of the Los Angeles County Coroner**

The Department of the Coroner (The Department) can trace its roots back to 1850 when the first Coroner, Charles Cullen, was appointed. In those days, the annual homicide rate in El Pueblo de Los Angeles was nine percent of the population on top of deaths from natural causes, accidents and suicides. As a result, the first Coroners were busy with inquests<sup>2</sup> on almost a daily basis. In the intervening 159 years, the homicide rate dropped from 9 to .009 percent, but the Coroner is the busiest forensics organization in the country investigating 9,200 cases and performing 6,900 medical examinations a year.<sup>3</sup>

Mission of agency: The Department is mandated by law to inquire into and determine the circumstances, manner, and cause of all violent, sudden, or unusual deaths occurring within Los Angeles County, including all homicides, suicides, accidental deaths, and natural deaths where the decedent has not seen a physician within 20 days prior to death. Statutory authority for the Coroner is derived from the California Government Code (e.g., 27491) and the Health & Safety, Vehicle, Penal, and Evidence codes.



The former County hospital administration building is now used by the Coroner for public services and archives.

---

<sup>2</sup> An inquest involves impaneling a jury to hear testimony about and determine cause and manner of death.

<sup>3</sup> In 1850, the population of LA County was 8,300. In 2009, LA County had a population of 9.8 million.

The agency is responsible for:

- Investigating all deaths that fall within the statutory responsibility of the agency, including identification of decedents and notification of next of kin,
- Performing examinations and autopsies of decedents where such procedures are necessary for determining cause and manner of death and/or for supporting the criminal litigation process,
- Conducting laboratory tests to determine findings in toxicology, histology, and analysis of gunshot residue and tool marks,<sup>4</sup>
- Transporting decedents to and from hospitals, the coroner facility, mortuaries, death scenes, etc.,
- Tracking and securing decedent's personal property, drugs, and evidence from death scenes,
- Tracking and maintaining records on cause and manner of death for perpetuity, and
- Providing reports and other documentation to the public, members of the law enforcement community, the insurance industry, etc.

In addition to core mandated functions the Agency operates a variety of specialized functions, some non-mandated, such as:

- A youthful drunk driver diversion program,
- A program that ensures that the remains of indigent veterans are given a dignified burial in a national cemetery,
- Specialized investigatory functions such as sudden unexpected death syndrome (SUDS), and

---

<sup>4</sup> A tool mark is any mark left on bone or tissue from a tool such as a knife, screwdriver, ax, etc.

- A unique gift shop that sells coroner-themed clothing and souvenir items.

The Agency is comprised of highly credentialed scientific staff such as the medical examiners; investigators who conduct cause of death investigations in the field; transport staff who transport remains between the field, the Coroner facility, various mortuaries and funeral homes, and hospitals; criminalists and lab technicians; administrative staff; and a range of other specialists. Staff are mostly based out of the Mission Road facility with some investigative staff out-stationed in South Los Angeles, Antelope Valley and the San Fernando Valley.

Key workload figures and statistics include (2008-09 figures unless stated):<sup>5</sup>

- 6,584 autopsies performed
- 9,069 death investigations performed
- 60,369 toxicology lab tests performed
- 209 budgeted positions (per 2009-10 proposed budget)
- \$28 million budget (per 2009-10 proposed budget)
- 10% of the agency budget (\$2.9 million) is supported by revenue such as fees for transporting and storing decedents, providing forensic testing services, document sales and collecting DNA evidence for State missing person registries. The remainder of the budget (\$25 million) is Net County Cost (NCC)

---

<sup>5</sup> Comparisons to peer counties can be found in Appendix D. On an absolute basis, Los Angeles County has the largest volume of medical examinations and investigations in the nation under one roof.

## Accomplishments

In addition to day-to-day accomplishments, such as investigating and determining cause and manner of death, serving families of the decedents, and working with the mortuary industry and the justice system, the Coroner can also claim credit to a number of accomplishments:

- The Agency is fully accredited by every relevant accrediting organization including the National Association of Medical Examiners (NAME), American Society of Crime Laboratory Directors (ASCLD-LAB), Accreditation Council for Graduate Medical Education (ACGME), California Medical Association for continuing medical education (CME), and Peace Officers Standards and Training (POST). Full accreditation, such as that enjoyed by the Los Angeles County Coroner, is relatively rare in the medical examiner world and is indication of the emphasis on quality on the part of Agency management,<sup>6</sup>
- The Department is timely, responsive and well prepared for criminal justice agencies (including law enforcement, the District Attorney, Public Defender and the courts),



A Coroner Forensic Identification Technician is an expert at identification support and fingerprint rehabilitation

---

<sup>6</sup> It should be mentioned that NAME accreditation is not a requirement for a coroner agency. In fact, most coroners in the U.S. are not accredited.

- The Department has worked hard to cultivate good relations with the Public Administrator and the funeral and mortuary industry,
- The Department provides timely and responsive service to State agencies (missing person registries and physician licensing), and
- Los Angeles County Coroner cases are well documented. The scope and level of detail in the investigation and cause of death reports is extensive and thorough. The quality of the case documentation is also well regarded by members of the criminal justice community,
- The Department has invested in new technology to enhance investigations (e.g., gun shot residue or GSR, digital radiography) and is considered a leader in GSR, toolmark and skeletal analysis,
- The Agency has recently embarked on the first significant facility upgrade (500-body Crypt/Biological Building Renovation) since the 1970s,
- The Department recently implemented the Veterans Indigent Burial Program,
- The Department has successfully pursued Homeland Security grants to acquire a substantial amount of emergency equipment and has trained staff to prepare for mass-casualty events,
- Some of the Coroner staff are renowned in their field with national and international reputations in forensic sciences, and
- In 2007 the Coroner published a neuropathology atlas covering case material from over 30 years of autopsies.

### **Project Objectives/Scope**

The scope of this project is to conduct a management audit of the Los Angeles County Coroner to evaluate agency operations, policies, procedures, and programs to provide the basis for recommendations for improving the effectiveness and efficiency of program operations and service delivery. In addition, the audit included benchmarking and best practices analysis to evaluate specific operations and the overall Coroner performance.

The audit included a review of all significant areas of Coroner operations and a review of all relevant operational and financial data from 1999 – October 2009.

### **Standards Used**

The consultants conducted this management audit in accordance with general and performance audit standards regarding qualifications, independence, due professional care, quality control, fieldwork, and reporting prescribed by the U.S. General Accounting Office (GAO) in Government Auditing Standards (2007 Revision).

### **Methods Used**

The management audit was conducted in three phases:

**Phase I – Preliminary Survey.** In the preliminary survey phase, the consultants held an entrance conference; gathered information about Coroner operations; reviewed the agency's current accreditation status; initiated a peer agency benchmark survey; reviewed prior audit reports; prepared an agency profile that



presented potential areas of risk or potential improvement; and developed a detailed workplan for the subsequent audit phase of the project.

An essential part of the preliminary survey was obtaining the views of key internal and external stakeholders. The consultants conducted over 30 interviews of County staff, Coroner staff and outside observers and stakeholders. These stakeholders included representatives from:

- State agencies such as the Department of Justice,
- Representatives from the mortuary industry,
- Other County and city agencies such as the District Attorney, Public Defender, Sheriff, Public Health, and LAPD, and
- The County Board of Supervisors

The consultants also conducted a review of pending legislation and litigation that may impact the operations or financial integrity of the Coroner.

**Phase II – Audit Phase.** In this phase, the consultants performed the tasks incorporated in the Phase II workplan. These included:

- Benchmarked Coroner performance against peer agencies,
- Reviewed Coroner strategic planning,
- Evaluated the Agency's organizational structure,
- Assessed the Agency's ability to recruit and retain physicians,
- Evaluated Agency morale and the work culture,
- Evaluated Agency staff turnover,

- Evaluated overtime utilization,
- Evaluated security measures use to protect staff and facilities including the use of weapons, monitoring of visitors and custodial staff,
- Evaluated the handling of the cadaver detection dog,
- Evaluated measures and policies for detecting and controlling infectious agents,
- Assessed possible decedent storage backlogs,
- Evaluated custodial procedures used for decedent property and evidence,
- Mapped out and evaluated custodial, investigation and medical examination processes and validated these maps by performing ridealongs and job shadowing,
- Examined and evaluated agency information and case management systems, including security over high profile cases,
- Evaluated Agency document management and backup systems and policies,
- Evaluated Coroner facilities and plans for renovating these facilities,
- Evaluated Agency financial management with respect to services billed to outside entities and the ability to recover costs through rates, and
- Evaluated cost recovery performance for the gift shop and projections for a planned DNA lab.

At the conclusion of Phase II, the consultants discussed preliminary findings and recommendations with the Auditor-Controller and Coroner management.

**Phase III – Reporting Phase.** In this phase, the consultants prepared a draft report based on the results of Phase II, conducted an exit conference with Coroner and Auditor-Controller staff, and finalized the report.

## ***Findings and Recommendations***

### **Section A – Human Resources**

The Department has 209 budgeted positions for FY 2009-10.<sup>7</sup> These positions range from highly credentialed staff such as forensic pathologists to entry level student workers. In between are positions that cover a range of qualifications such as investigators, transport workers, forensic scientists, evidence custodians, autopsy technicians, administrators, and records administrators.

#### **Physician Staffing**

The Department currently employs 24 physicians who perform medical examinations in the Forensic Medicine Division. In addition, a Chief Physician supervises all the physicians, assigns cases and conducts forensic research. Finally, the Division is headed by the Chief Medical Examiner-Coroner. Neither the Chief Physician nor the Chief Medical Examiner-Coroner perform autopsies on a routine basis, but are directly involved in the closure of complex cases, various administrative functions, and performing autopsies of high profile decedents.

The most important benchmark in physician staffing is the ratio of annual autopsies per physician. The National Association of Medical Examiners (NAME) standard is 250 autopsies per physician.<sup>8</sup> As seen in Figure A1, the Agency has been at or near the benchmark since FY 2004/05. During the early 1990s, the

---

<sup>7</sup> Four positions were vacant as of July 1, 2009

<sup>8</sup> Autopsies are counted as one autopsy unless it is only an external examination (Class D autopsy according to Los Angeles County Coroner standards), which are counted as a .5 autopsy. One hundred autopsies and 100 external examinations would then be counted as 150 autopsies.

ratio was much higher due to the higher number of homicides during that time.<sup>9</sup> Currently, the Coroner has adequate physicians on staff to meet NAME standards.

**Figure A1 – Autopsies/medical exams per physician<sup>10</sup>**

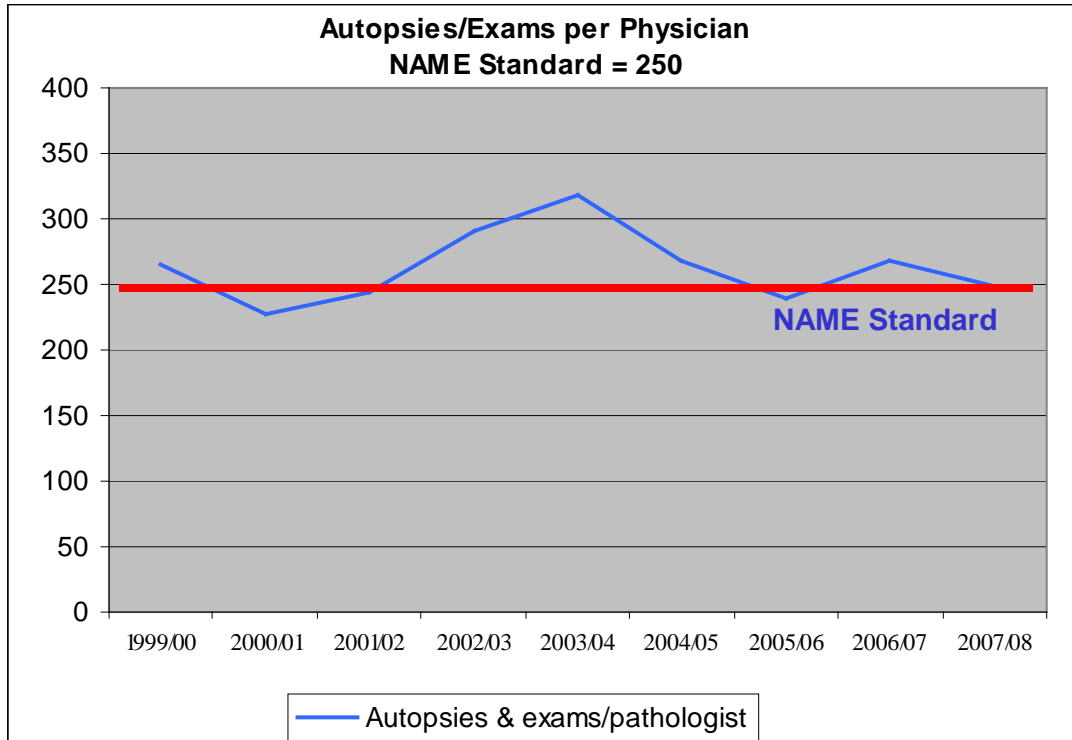

By the year 2014, the Agency is likely to experience a severe shortage of physicians, which could threaten the Agency’s ability to meet the NAME standard of 250 autopsies per physician per year and may result in autopsy backlogs and loss of the NAME accreditation.<sup>11</sup> This projected shortage of physicians is due to two key reasons:

1. The physician staff is aging and many are nearing retirement age. The mean number of years of County employment among the 24 physicians is

<sup>9</sup> Los Angeles County experienced 1,944 homicides in 1993. In 2008, the number had dropped to 806.

<sup>10</sup> Autopsies are counted as one autopsy unless it is only an external examination

<sup>11</sup> The extent of potential backlogs is impossible to forecast accurately however our model forecasts a per physician workload of 311 autopsies and exams within five years, approximately 25% higher than current workloads.

16 years. Eight of the 24 physicians have at least 20 years of County employment. Based on the tenure of the physicians and the rate that new physicians are added to the staff, our projections show a shortage of three physicians by 2010, five physicians by the year 2014 (4 years) and eight physicians by 2019 (9 years). Assuming no growth in the caseload, the agency will exceed the NAME standard by 31 cases per physician beginning in 2010.<sup>12</sup> The chart below shows the projected workload ratio for the next 10 years using our projections (See Appendix B for the detailed projection).

**Figure A2 – Autopsies/medical exams per physician**

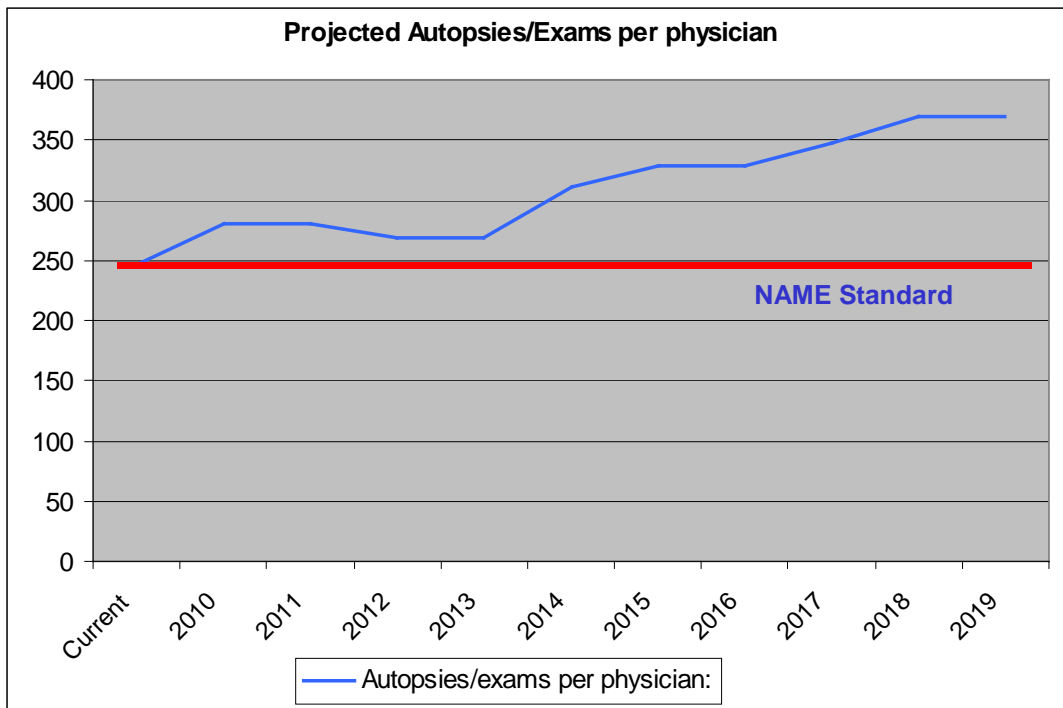

2. In recent years the Agency has had difficulty retaining postgraduates once they have finished their fellowships. The Department has historically been

---

<sup>12</sup> Our model forecasts that per physician caseloads will exceed NAME standards by 31 cases starting in 2010 and increasing to 119 by 2019.



a key training facility for forensic pathologists.<sup>13</sup> Most of the current pathologists on staff were trained by the Agency. Significant resources are devoted to training postgraduates (forensic pathology fellows) and the Agency has residency agreements with UCLA, Cedars-Sinai and LAC+USC Hospitals.

Most recent post-graduate recruits have left forensics or moved to Coroner agencies in other counties. In the last five years, four of the Coroner's eight postgraduate fellows left County service. Three of the remaining four fellows were hired in 2009. In addition, there were three retirements or resignations of experienced physicians in the last five years for a net increase of one physician over the last five years. (See table A1)

**Table A1 – Physician recruitment and departures (2004-09)**

Physicians recruited	8
Recruits leaving County service	(4)
Retirements of experienced physicians	(3)
Net change in physicians (2004-09)	1

In some cases, postgraduate fellows are not accepted for permanent employment or leave for legitimate reasons that are outside the control of the County such as leaving the State for family reasons. However, other factors can and should be addressed:

- Unattractive and outmoded facilities (now being renovated). Compared to newer, more modern forensic pathology facilities in other jurisdictions, the Coroner's Forensic Sciences Center (the 1104A biological building) is significantly less attractive as a workplace.

---

<sup>13</sup> A Forensic Pathologist is a physician who specializes in Forensic Pathology.

- California has more stringent licensing requirements for physicians than neighboring states, which makes it more difficult to attract forensic pathologists who were not trained in California.
- The Los Angeles County Coroner has strict background check requirements that many potential staff physicians either do not want to undertake or may not pass.
- Inadequate mentoring from more experienced physicians. In at least one case, the message from an experienced physician to a post-graduate was that the Agency is not a desirable employer and that they should seek permanent employment elsewhere.

The agency has or is undertaking some initiatives to address the impending physician shortage. For example, in 2008 the Coroner initiated a Board approved as-needed physicians contract and received interest from three local private forensic pathologists to perform autopsies on an on-call basis. However, the contract has not been funded due to budget curtailments and therefore has not been utilized.

The Department has started exploring the use of Pathology Assistants to perform medical examinations. Pathology Assistants are not physicians and are not licensed by the State but can be certified by the American Association of Pathologists Assistants (AAPA) or the Board of Registry of the American Society for Clinical Pathology. Pathology Assistants are less expensive than physicians and are relatively easier to recruit due to the less stringent licensing requirements and more plentiful supply. Pathology Assistants are used in a variety of medical settings, including forensics. They can be used to conduct post-mortem examinations under the supervision of a licensed physician. A practical use of Pathology Assistants at the Coroner would be to perform external-only medical

examinations (i.e., sign-outs)<sup>14</sup> and autopsies for uncomplicated cases. Pathology Assistants should not be utilized for more complicated cases such as homicides, infant deaths or therapeutic misadventures.

The Department is currently negotiating with Rosalind Franklin University in North Chicago to provide training to Pathology Assistant trainees through a joint program with UCLA School of Medicine. Residents would train under the supervision of Coroner staff physicians and would be a potential source of permanent Coroner forensic medical staff upon completing their training.

One hurdle to using Pathology Assistants is that the County does not have a classification that would apply to Pathology Assistants. This classification would have to be created before the program could be fully implemented.

**Recommendations:**

**Recommendation A1** – The Department of the Coroner should continue pursuing a Pathology Assistant training and residency program (e.g., with Rosalind Franklin University and the UCLA School of Medicine).

**Recommendation A2** – The Department of the Coroner should work with the County Department of Human Resources to create a Pathology Assistant job classification and a competitive salary range.

**Recommendation A3** – The Department of the Coroner should request an appropriation to fund the on-call forensic pathologist contracts for 2,000 hours per year beginning in FY 2010-11.

**Recommendation A4** – The Department of the Coroner should appoint a mentoring director among the staff physicians and establish a code of

---

<sup>14</sup> Sign-outs are medical examinations that do not require invasive dissections other than small incisions to draw fluid samples.

conduct for physicians in dealing with physician postgraduates. Establish a resident mentorship program.

## Workplace Culture

Workplace culture is the sum of behaviors, rules, power relationships, styles of interaction, methods of recognizing staff and work habits that tend to pervade an organization. Sometimes the work culture tends to mirror whatever policies and procedures are put in place. Oftentimes, the work culture can supersede the official human resource policies on dress code, promotion policies, etc. and are a powerful influence on how people view their co-workers, their level of job satisfaction and their performance. We evaluated workplace culture at the Coroner to determine whether it was conducive or obstructive to maximizing employee performance. We gathered employee feedback on a number of criteria:



- Understanding and buying in to agency strategy and goals,
- Access to career development opportunities such as training,
- Effective communication throughout the organization,
- Sufficient tools and equipment to do the job,
- Fair and equitable allocation of workload,
- Sufficient authority and responsibility to do the job,
- Respectful and supportive relationships with superiors,
- Friendly and cooperative relationships with co-workers,
- Realistic, understandable and measurable performance criteria,
- Frequent and objective feedback from managers, and
- Belief that recognition is linked to performance.

Using these criteria, the Agency's work culture was determined by conducting focus groups with staff and an agency-wide, confidential survey. The chart on the next page graphically shows the results of these surveys.

**Table A2 – Work Culture Survey Results**

LA Coroner Work Culture Survey Results	Organizational Unit:							
	Agency-wide	Investigations	Forensic Medicine	Decedent services	Public Services	Labs	Admin Bureau	Bureau/Div managers and their admin staff
Understanding and buying in to agency strategy and goals	Yellow	Red	Yellow	Red	Green	Green	Yellow	Green
Access to career development opportunities such as training	Yellow	Red	Yellow	Red	Green	Yellow	Yellow	Green
Effective communication throughout the organization	Red	Red	Yellow	Red	Green	Yellow	Yellow	Green
Sufficient tools and equipment to do the job	Yellow	Red	Yellow	Red	Green	Yellow	Green	Green
Fair and equitable allocation of workload	Yellow	Yellow	Yellow	Yellow	Green	Yellow	Green	Green
Sufficient authority and responsibility to do the job	Green	Yellow	Green	Yellow	Green	Yellow	Green	Green
Respectful and supportive relationships with superiors	Green	Yellow	Green	Yellow	Green	Yellow	Green	Green
Friendly and cooperative relationships with co-workers	Green	Yellow	Yellow	Yellow	Green	Yellow	Green	Green
Realistic understandable & measurable performance criteria	Yellow	Red	Yellow	Red	Yellow	Yellow	Green	Green
Frequent and objective feedback from managers	Yellow	Red	Yellow	Red	Green	Red	Yellow	Yellow
Belief that recognition is linked to performance	Red	Red	Yellow	Red	Yellow	Red	Yellow	Yellow
Overall satisfaction	Yellow	Yellow	Yellow	Yellow	Green	Yellow	Green	Green

Note: There were not enough responses from the Forensic Support Division.

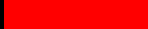
<b>Color key:</b>	
	Positive responses
	Mixed responses or no central tendency
	Negative responses

As seen in the chart, agency-wide results were mixed. Positive results were received from the Public Services Division and the Administration Bureau and among upper management and affiliated administrative staff.<sup>15</sup> The Agency scored highest in:

- Sufficient authority and responsibility to do the job,
- Respectful and supportive relationships with superiors, and
- Friendly and cooperative relationships with co-workers.

In many areas, a majority of respondents also reported that they enjoyed the work and were proud to work at the Coroner.

The Agency scored lowest in:

- Effective communication throughout the organization, and
- Belief that recognition is linked to performance.

These points were reinforced in the focus group feedback as well.

The survey requested input on areas where the most urgent improvement was needed. These areas were identified as follows:

- Consistent and equitable treatment of staff,
- On-site security,
- Inter-divisional cooperation and internal communication,
- Adequate supplies and equipment, and
- Facilities.

The two areas of most concern are the Investigations and Decedent Services divisions. The Investigations Division in particular showed significant negative survey scores reinforced by negative interview and focus group input. Many of the problems seem to center on a perceived disconnect between employee

---

<sup>15</sup> There were not enough responses from the Forensic Support Division to quantify or draw conclusions.



performance and recognition, perceived favoritism, and inequitable treatment of staff.

Comments made by employees in focus groups and interviews indicate that many employees feel that their contributions are not valued, that they are not treated fairly, and that their work is not fairly evaluated.

Many described a climate of favoritism in which some employees are given privileges (e.g., take take-home cars), are not disciplined, and get better assignments. For example, many employees point to favorable work assignments given to former employees of the Arcadia Police Department as evidence of uneven treatment.

It is difficult to pinpoint the cause or causes of negative work culture but upper management has the responsibility for recognizing the problem and taking the appropriate actions to mitigate the negative attributes and/or to set an example for mid-level supervisors in the areas where the negative cultural attributes have taken root. Although neither turnover rates nor performance appear to be a problem in the Division, negative work culture attributes such as those reported could have a tendency to build and eventually create performance and retention problems if not addressed.

Bias – perceived or real – undermines employee morale. When bias is perceived, Managers and supervisors can address the perception by clearly communicating and equitably enforcing policies and procedures, providing prompt feedback about both good and poor performance, and sharing his or her rationale for assignments or promotions. According to employee comments, these actions are not being taken often enough.



The Agency would benefit from a shift in the organizational culture that would value good employee/supervisory relationships, recognize and reward effective supervisors and managers, and provide supervisory/management training to improve and enhance management skills. Over time, such measures should result in improved job satisfaction, retention and employee performance.

**Recommendation A5** - The Department of the Coroner management should better communicate, monitor and enforce criteria for promotions, recognition, and assignments to ensure they are predictable and consistent.

**Recommendation A6** - The Department of the Coroner should establish formal lines of communication beyond the existing chain of command structure with these two units to address issues, perceived or otherwise.

## Take-Home Cars

The agency has a take-home car program whereby assigned investigators are provided with County vehicles for conducting field investigations during regular work hours and during their time off. As with other public safety departments the vehicles are fueled, maintained, and insured by the County. In return, the investigators assigned the take-home cars are obligated to respond to calls during the late night and early morning hours in any area throughout the County. This program has replaced the need for a graveyard shift of investigators.<sup>16</sup> Some consider a take-home car a lucrative perk as they are permitted to use it to commute back forth to the Coroner campus although commuting is the only non-work usage allowed by policy. Because there are not enough take-home vehicles for all investigators, however, clear criteria and conditions to assign vehicles should be in place. The Field Response Vehicle Program Policy states in part:



“Assignment will be at the discretion of management based on workload levels, financial constraints, and required service and operational needs.”

And

“The supervisor shall . . . make recommendations based on the quality and consistency of the employees overall work product, attendance, performance evaluations (competent or better), driving

---

<sup>16</sup> A watch commander and call desk person still work the graveyard shift to take calls and assign them to investigators.

history (no at-fault accidents or DMV points assessed), historical availability for scheduled or unanticipated overtime, call-back, after-hours call outs, and geographic location of primary residence. Seniority will not be weighted greater as a determining factor in the decision to assign a vehicle to a particular Coroner Investigator.”

When a call comes in during late night/early morning hours, the watch commander will contact an investigator who resides in the area of the death scene. If the investigator does not respond, declines or is otherwise unable to travel to the scene the watch commander will try another investigator. As stated in the policy, availability for responding to these calls is a key criteria in determining who is assigned the take-home vehicles. The table below shows the response rate for the investigators assigned these vehicles during 2008 and 2009.

**Table A3 – Off-Duty Call Response Rates**

<b>Investigator ID</b>	<b>Home location</b>	<b># of calls</b>	<b># responded</b>	<b>% responded</b>
Inv. 1	Upland	19	19	100%
Inv. 2	Altadena	59	59	100%
Inv. 3	Altadena	33	33	100%
Inv. 4	Long Beach	76	75	99%
Inv. 5	San Bernardino	36	35	97%
Inv. 6	La Canada Flintridge	69	64	93%
Inv. 7	Claremont	29	22	76%
Inv. 8	Whittier	12	9	75%
Inv. 9	Monterey Park	20	15	75%
Inv. 10	Chatsworth	44	27	61%
Inv. 11	Playa del Rey	33	16	48%
Inv. 12	Ontario	12	5	42%
<b>TOTAL</b>		<b>234</b>	<b>194</b>	<b>83%</b>

Of the thirty-one investigators working field investigations, excluding lieutenants and captains, twelve have take home vehicles, which is largely dictated by budget constraints. As seen in the table, six investigators respond to these calls at least 90 percent of the time. Two investigators respond fewer than half the time. The remaining four investigators responded from 61 to 76 percent of the time. As can

be expected with such a desirable perk, the program is monitored closely by those without the vehicles.<sup>17</sup> Given that the response rate varies considerably, the general assumption is that the take-home vehicle policy is subjectively enforced and the actual data seems to bear this out. The selective enforcement (or lack thereof) of this policy contributes to the perception of favoritism that pervades the Investigations Division.

**Recommendation:**

**Recommendation A7** – The Department of the Coroner should revise its Take-Home Car policy to clearly define eligibility for participation, a finite time-line for participation (so that other Investigators have the opportunity to participate), and the expected on-call response rate. Additionally, a process for tracking and monitoring on-call response rates should be developed to ensure compliance with Department policy and strictly followed to ensure transparency.

---

<sup>17</sup> Some investigators do not wish to take calls during off-hours and therefore are not assigned take-home vehicles.

**Section B – Organizational Structure**

The Department is currently organized along functional lines with four separate functional bureaus:

- An Operations Bureau that includes:
  - An Investigations Division that responds to, and investigates death scenes, identifies bodies, notifies families, and examines bodies that have been brought to mortuaries for final disposition,
  - A Decedent Services Division that manages the crypt, releases bodies to families and mortuaries, and is in charge of transporting bodies from scenes and hospitals to the Coroner facility, and
  - A Forensic Photo Support Division that works closely with the Forensic Medicine Division in preparing for and conducting autopsies, and managing photography files.
- An Administration Bureau that includes:
  - Separate units that handle budget, accounting, procurement, contracts and grants, human resources, payroll, information technology, and marketing,
  - A Public Services Division that manages case file records, medical clerical support, decedent’s personal property, case transcriptions, subpoenas and death certificates.
- A Forensic Lab Bureau that oversees a toxicology laboratory, a histology laboratory, the evidence custody function, and tool mark and gunshot residue analysis
- A Forensic Medicine Division overseen by the Chief Medical Examiner-Coroner. This unit performs and documents medical examinations, autopsies and determines cause and manner of death.

Figure B1 shows this structure in graphical form.

## Dual Executive Management

A unique feature of the current organizational structure is that there are two executives:

1. A Director who oversees the Operations, Administration and Forensic Lab Bureaus
2. A Chief Medical Examiner-Coroner who oversees the Forensic Medicine unit and carries out statutory Coroner functions.

This dual executive arrangement originated from a Board of Supervisors ordinance reorganizing the Department in 1990 with the intent of improving operations. The rationale at the time was that the Department was too complex to rely on a single executive who could manage the administrative responsibilities as well as the medical functions. The current Chief Medical Examiner-Coroner and Director have held these positions since 1992 and 1994, respectively. The dual executive structure generally accomplishes this objective and the incumbents have an effective working relationship. In addition, the Department has had a good track record under the current structure. However, the structure itself is more costly than structures with one chief executive due to the additional senior position. In addition, there is no single point of accountability within the Department.

Among peer agencies, none have a dual executive structure including the five largest counties (other than Los Angeles) in the nation that have a standalone medical examiner agency.<sup>18</sup> Among large California counties that have

---

<sup>18</sup> The five largest surveyed include New York City (actually five separate counties), Cook (Chicago), Harris (Houston), Maricopa (Phoenix) and San Diego. Orange County is larger than San Diego but does not have a separate medical examiner department.

standalone medical examiner agencies, none have a dual executive structure, however, none come near the size of LA County.<sup>19</sup>

The dual management structure is effective for a number of reasons, including the strong working relationship of the two individuals involved. The Chief Medical Examiner-Coroner has been with the County service for 32 years and the Director has been with County service for 37 years. When either or both retires in the next few years, the structure may (or may not) become ineffective with different people involved. The Agency has a succession plan (dated May 2009), but the plan does not include actions to address the likely retirement of the two executives within the next few years.

**Recommendation:**

**Recommendation B1** - When the opportunity arises through retirement, the CEO/Board of Supervisors should consider consolidating the agency under a single chief executive position. Unifying command of the agency under a single position is inherently more efficient and eliminates the effect of personality on the effectiveness (or lack thereof) of the management structure.

## Division Reorganization

The current structure also features disparities between reporting lines and actual workflows for the Forensic Photo and Support Division. This unit reports through the Operations Bureau yet works mostly with the Forensic Medicine Division. In fact, these units are located in the same building and work almost exclusively with each other. Forensic Technicians, the primary classification in the Forensic Photo and Support Division, work side by side with Medical Examiners in the autopsy

---

<sup>19</sup> San Diego and Sacramento have standalone agencies.



rooms and perform many functions that support the physicians in their examinations.

**Recommendation:**

**Recommendation B2** – The Department of the Coroner should transfer the oversight responsibilities of the Forensic Photo and Support Division to the Chief Medical Examiner-Coroner.

**Figure B1 –Current Organizational Structure**

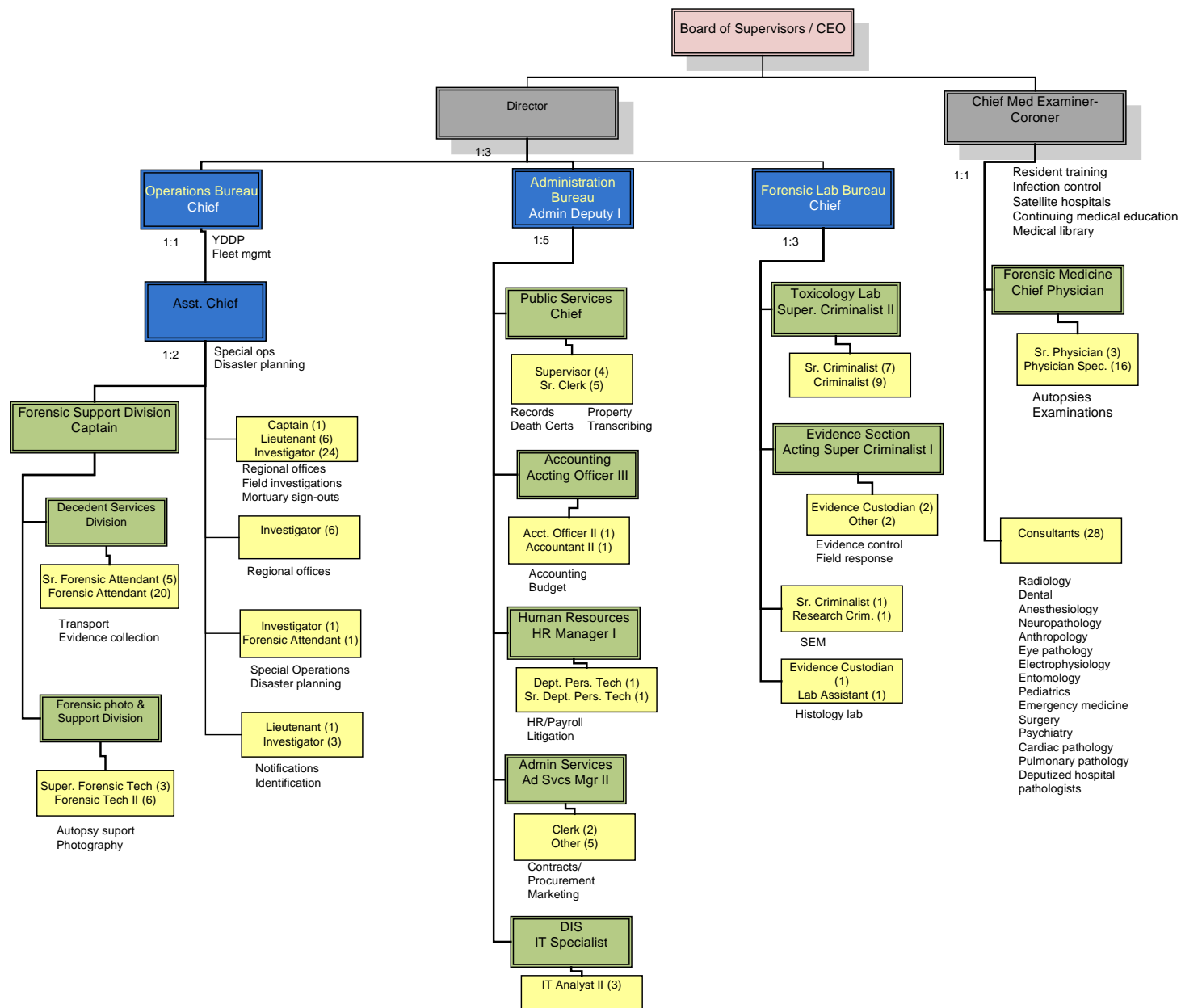

**Section C – Work Processes**

## Data Collection and Documentation

Process mapping is an effective way to illustrate workflows, how systems and forms are used, how paper and information is transferred around the organization, and how work is transferred among different staff. Process inefficiencies are easily identified by analyzing the process maps. In our fieldwork, we mapped eight key Coroner processes:

1. Clearance cases (those that fall under Coroner jurisdiction but where the Coroner declines further inquiry and allows the primary doctor to sign the death certificate),<sup>20</sup>
2. Mortuary Sign-outs (where an investigator in consultation with a medical examiner will examine a body at the mortuary, but the body will not be transported to the Coroner for further investigation or autopsy unless there are questions about the cause and manner of death or there are signs of foul play),
3. Field Calls (where an investigator responds to the field to investigate a sudden or unexpected death, often an accident, suicide or homicide),
4. Autopsy scheduling,



---

<sup>20</sup> Clearance cases are typically where the decedent dies under a doctors care, the cause of death is known, and the manner is natural. The decedent may not have seen a doctor in the previous 20 days before hospital admission.

5. Full autopsy,
6. External examination only (where a physician examines the body but does not perform any invasive procedures other than to collect fluid samples. Also called a sign-out.),
7. Decedent property handling, and
8. Law enforcement document request.

Mapping these processes involved direct observation out in the field, in the autopsy room, or in Coroner staff offices; collection of documents and forms; and preparation of process maps. These maps can be found in Appendix C.

Los Angeles County Coroner cases are well documented. The scope and level of detail in the investigation and cause of death reports is extensive and thorough. The quality of the case documentation is also well regarded by members of the criminal justice community.

However, there is also quite a bit of redundant data collection embedded in the processes. The same data elements are frequently collected, written down or input multiple times. This redundant data collection can be beneficial in that certain documents can be corroborated across the case file. However, redundant data collection is inefficient and results in more paper documents in the file than is necessary.

The redundancy is the result of an over-reliance on paper-based data collection and a lack of automated workflow technology that can efficiently collect, store and transfer data

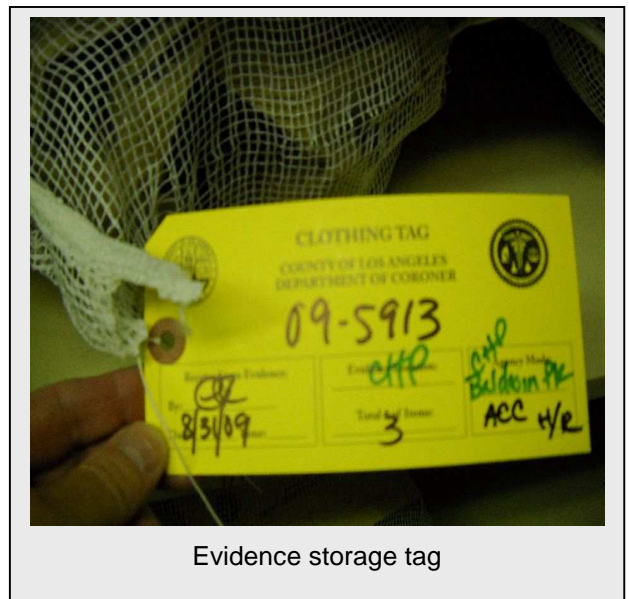

Evidence storage tag

in digital form. Data collection is also very reliant on paper forms and obsolete multi-part forms. We also observed the use of obsolete systems for labeling bodies, samples, specimens, evidence, case files and property. Frequently this involves the use of decades-old imprinting devices similar to how credit card purchases used to be handled or handwritten tags.

All of these materials and bodies could be more efficiently labeled and tracked using a single system to record the source, location and disposition of each item and to print barcoded labels to apply to the items. This would allow a much better audit trail as barcode scanners could be deployed to record the transfer and receipt of each item and its location.

Pre-printed labels, barcoded with the case number, could be produced and taken to scene investigations and used to label property and evidence. Labels could be used to label bodies and associated crypt locations. Pre-printed labels could be used in autopsy rooms for labeling specimen jars. Documents received and printed could be labeled with pre-printed, barcoded labels and then scanned into a document management system. Barcode-based labeling for specimens, patients or decedents, and documents is the industry standard for medical settings particularly in high-volume venues like hospitals and large medical clinics. It is also becoming more common in Coroner agencies.

There was no indication that losing case files, evidence, property, specimens and bodies is an issue at the Coroner. On the contrary, there are many examples of cold homicide cases that are reopened and resolved with the help of evidence that has been stored at the Coroner for many years and easily recovered. However, a barcode-based tracking and

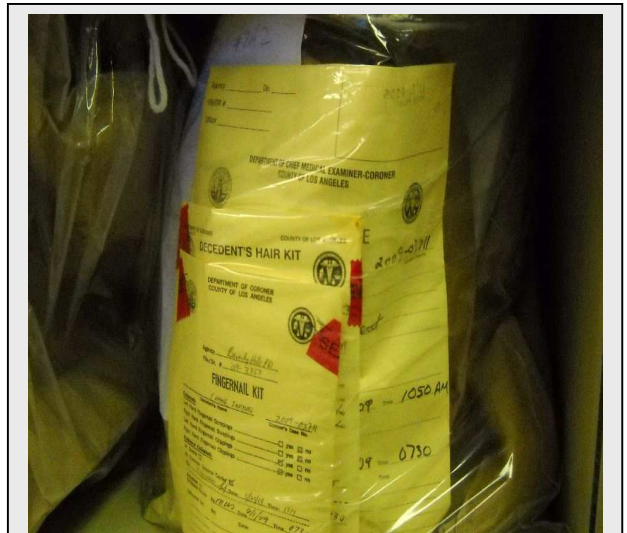

Crime scene evidence bag

labeling system coupled with a document management system would expedite the transfer, receiving and storage of items, eliminate all the redundant and duplicative systems and paper forms and provide a better audit trail.

**Recommendations:**

**Recommendation C1** – The Department of the Coroner should continue its efforts to implement workflow technologies using a case management system and the County’s planned Documentum<sup>21</sup> document management system to replace the reliance on paper case files and inefficient document preparation and transfer practices.

**Recommendation C2** – The Department of the Coroner should test touchpad-based data collection tools (e.g., laptops or other field recording devices) for medical examiners and investigators.

**Recommendation C3** – The Department of the Coroner should implement barcode labeling for all bodies, materials, specimens, samples and documents. If possible, it should use the Documentum system to produce labels based on case numbers generated in the case management system.



---

<sup>21</sup> A document management system produced by EMC. This system is described later in the report.



## Case Management System

The existing case management system is called the Coroner Medical Examiner (CME) system. It is published by VertiQ of Morgan Hill, CA. CME is a programming workflow toolkit that allows each client to customize the features and processes of the system. CME is used by over 40 coroner agencies including most large California counties. The system is 10 years old and was originally written in Visual Basic but was re-programmed as a web-based version in 2006. Los Angeles County is the only user still using the Visual Basic version. VertiQ has significantly curtailed vendor support for the Visual Basic version and has been encouraging the Coroner to convert since the 2006 migration. However, since the software is custom written for each County, conversion to the web-based version entails rewriting the new version to match the County's work processes which also requires budgetary investment.

The Coroner has never really implemented workflow technologies in its case management system. CME is primarily used as a typing tool for many documents that are then printed and put into a paper case file. Coroner processes feature several examples where information is entered into CME, printed out, sent to another Coroner employee for review when that employee could easily review the information in CME.

In addition, major parts of the organization have never adapted to CME. After several unsuccessful attempts at integration by the vendor, the toxicology lab will not use the CME tox lab module and has instead implemented their own customized system



using MS-Access.<sup>22</sup> There is no interface between the homegrown MS-Access and CME systems. The dispatch area enters crypt locations in CME when a body is delivered but uses the information only for confirming release of the correct body, relying instead on paper body control cards and the crypt reader board on the wall.

In addition, once a case is closed and the workflow activities stop, CME doesn't incorporate the next step: case file archiving and document management. CME doesn't have a document management component, which as described in more detail later, breeds inefficiencies in the ability to store, retrieve, share and transfer case data and ensure effective data backups. CME also has security vulnerabilities that are addressed in the Data Security section of this report. Finally, CME does not interface with the other major system that the Coroner uses, the Electronic Death Registration System (EDRS) which is administered by the California Department of Health Services. This creates some minor inefficiencies in sharing and synchronizing cause of death information between the two systems.

As mentioned earlier, the Coroner does not have an integrated document management system to capture and archive documents. The agency has taken preliminary steps to implement a document management system by producing a plan and securing a \$170,000 grant to purchase personal services and software to implement the Documentum product produced by EMC. Documentum is a new Countywide standard for document management. Documentum will support capturing documents that are either generated by Microsoft applications or CME or paper documents that are scanned. The software would create electronic case files that could be securely backed up, would facilitate efficient sharing of documents with law enforcement, and would support a more aggressive workflow approach than what has been done so far with CME. Documentum can also interface with a Case Tracking System so that the case management and data

---

<sup>22</sup> The toxicology staff is concerned about the lack of flexibility in the CME-based tox lab module especially the inability to modify test requests submitted by the physicians.



collection tools of CME can be used in concert. As part of its strategic planning, the Coroner plans to utilize Documentum as a platform to create a Case Management System replacement for CME.

**Recommendations:**

**Recommendation C4** – The Department of the Coroner should replace the MS-Access-based Tox database with a toxicology lab module integrated into the case management system.

**Recommendation C5** – The Department of the Coroner should continue its efforts to finalize the implementation of the Documentum platform and electronic case files. Once in place, the Coroner should continue its plan to implement a replacement Case Management System in Documentum.

## Decedent Services

The Decedent Services unit is responsible for transporting decedents between death scenes in the field, hospitals and the Coroner; Body intake and releases; and crypt management. The Coroner crypt has a capacity of 364 decedents. Several years ago, there were reports of the crypt routinely exceeding capacity and bodies being stacked on tables. Since that time, the average crypt census has decreased substantially. The average census in the crypt per month in 2005 was 338. In 2009 that number has decreased to 248.<sup>23</sup>

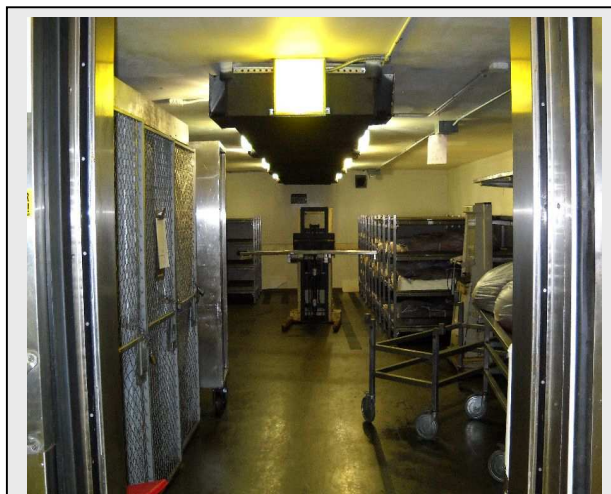

Main crypt

This reduction in the crypt census is attributable to several factors:

1. The Coroner is using a private cremation contractor to dispose of the bodies of indigent decedents. Prior to February 2009, the Coroner would rely on the County's crematorium (operated by the LAC+USC Medical Center Morgue) to dispose of indigent decedents. However, in February of 2009, Department of Health Services (DHS) stopped taking indigent decedents from the Coroner due to DHS' own increasing caseload of decedents. Faced without a cremation option, the Coroner was forced to contract with private cremation facilities to handle these indigent cases, which resulted in additional unbudgeted expense to the Coroner. LAC+USC Medical Center Morgue cremation services to the Coroner

---

<sup>23</sup> During 2009, the Coroner broke ground on a new crypt building that will adjoin the existing 1104 Mission Road building. This crypt will replace most of the existing crypt space at 1104 and have a capacity of 500 bodies (plus an additional 25 from remaining existing crypt space) for a total capacity of 525. While the Coroner's current crypt census shows numbers reflecting half of this capacity, the Coroner must be ready to respond to mass fatality disasters, which can quickly utilize the available space of the new crypt facility.

have been inconsistent and reports of routine stoppages over the years have had a negative effect on the work flow and movement of indigent cases. In 2007 a similar stoppage of cremation services took place when both the Coroner and LAC+USC Morgue were experiencing high caseload compounded by excessive heat. These factors combined resulted in a crypt census that rose to 477 (near the maximum limit of the proposed new crypt building). A leveling of caseload, reopening of the LAC+USC Morgue services, and a more efficient handling of Doe cases contributed to the resolution of these issues at that time.



2. The Coroner has been more proactive in identifying the John and Jane “Does” that come into the crypt, thereby moving them on to final disposition once next of kin has been identified.
3. The Department has taken a very aggressive and compassionate approach to dealing with indigent veterans’ remains. Previously, indigent veterans’ remains were kept at the Coroner until the Veterans Administration (VA) assigned a private mortuary to have the remains picked up and transferred to Riverside National Cemetery (RNC), a process that could take several months. The Coroner staff now makes the burial and delivery arrangements themselves and contracts directly with the RNC for final disposition.

County Code 2.76.080 assigns responsibility for cremating indigent decedents of Los Angeles County to the DHS. According to Coroner management, two-thirds of

all indigent deaths in the County are non-Coroner cases and have no relation to the Coroner's public safety mission of determining cause and manner of death.

**Recommendation:**

**Recommendation C6** – The CEO, in conjunction with the Coroner and DHS, should review the current DHS/Coroner processes and costs of handling the indigent dead to determine if appropriate resources, staffing, equipment, infrastructure (facilities, crematories) exist to adequately meet the needs of all County indigent decedent cases in a cost effective manner, whether the process complies with existing County ordinance, and whether other options such as outsourcing should be considered.

## Data Backup and Archiving

Much of the data collected and stored at the Coroner is not backed up. The following describes the current status of each class of data:

- Digital files, photos, radiographs (most dating from 2008 to the current day) are kept on ISD servers and backed up daily to tape and an out-of-County location. As mentioned later, some of these images have been corrupted.
- Pre-digital photographs and radiographs (2007 and prior) are in negative or Polaroid print form and not backed up. They are stored in various locations at the Coroner facility in sprinklered, secure rooms.
- Case files are maintained on one of the following media depending on the year: paper, fiche, optical disk or microfilm. There is no backup for any of these case files though the source files may be in CME or in MS-Word files. The Department is scanning backfiles that date from 1997 onwards and storing the documents on ISD servers. In addition, files from 1990-93 are stored on optical disk and are being scanned over time.<sup>24</sup> The case files themselves are very orderly, secure and well protected from fire. Files from 1974 to the present day are stored in the red brick building on

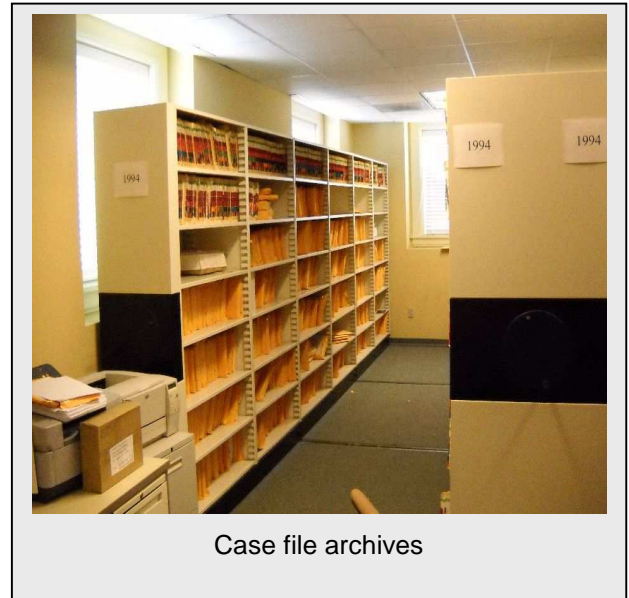

---

<sup>24</sup> If a request is received for a file that is on optical disk, all the files on that specific disk are converted to pdf and stored on ISD servers.

the Coroner campus. Pre-1974 files are stored at the Hall of Administration downtown. Access to file rooms is reasonably secure.

- Digital information such as CME data, case narratives, etc. are maintained on ISD servers and backed up daily to tape and to an out-of-County location.
- Unlike computers elsewhere in the agency, the computers used in the labs are not under ISD management and therefore critical data such as lab test results are not maintained or backed up digitally. Though test results are typically printed out and included in the paper case file, the digital test files in the Tox DB system should be maintained for archiving and research purposes.

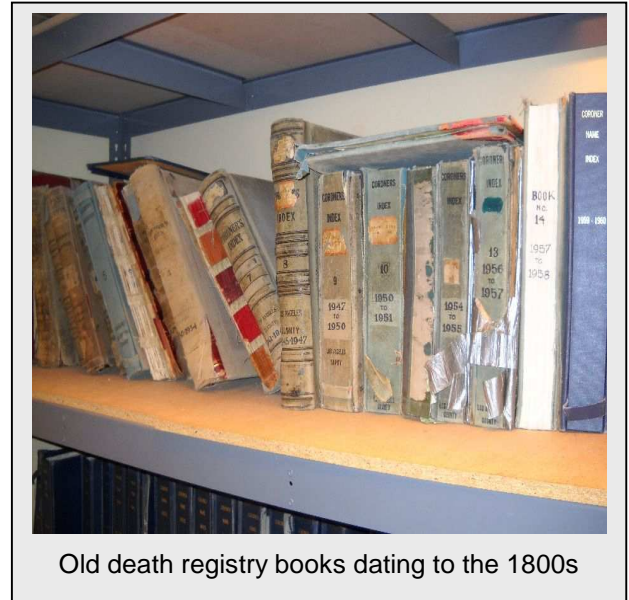

Many, if not most, of the case files are never viewed or queried once the final cause of death is determined. Queries that are received usually occur during the first five years after death, trickling off after that. The major exceptions are homicides which often result in lengthy trials and many requests for case file information. Since most files are in paper form, an outdated process (see Appendix C, Law Enforcement Document Request) has been built up to fulfill requests from external parties (mostly law enforcement) for files. Storing case files in digital form would greatly expedite these requests.

Major losses of data have occurred in recent years. Case files from 1996 were converted to digital form and the paper files were destroyed as part of a document retention procedure. Unfortunately, the media containing the digital files was rendered unreadable and all the case files from that year are now almost

completely gone.<sup>25</sup> This could be an issue if a cold homicide case from 1996 is reopened and case notes and findings are needed for prosecution. Lack of forensic evidence from a reopened 1996 case could compromise the ability to prosecute unless there is other compelling evidence (e.g., video evidence, witness testimony) to compensate.

In June 2009, it was discovered that six months of digital photographs<sup>26</sup> were corrupted with no backup. Data recovery efforts have been implemented and are continuing in an attempt to restore the photographs with some success. After the images were corrupted, the Coroner began storing all digital images on ISD servers which are backed up nightly. The practical impact of this loss is subject to debate but is unlikely to affect prosecutions in any material way as there are usually other photos available from law enforcement agencies and Coroner photos are just one evidentiary element among many in a case. In addition, the Coroner has been successful in reconstructing many of the corrupted images.

**Recommendations:**

**Recommendation C7** – The Department of the Coroner should scan all archived homicide cases that have not been disposed of (e.g., cold cases or not yet brought to trial), and cases from the previous five years starting with the most recent year.

**Recommendation C8** - The Department of the Coroner should transfer management of lab PCs to ISD to ensure adequate back-up.

---

<sup>25</sup> Some documents may have been copied and sent to law enforcement agencies and so some recovery is possible if needed.

<sup>26</sup> Estimates vary regarding the exact number of corrupted photos but it is believed to be around 170,000 images. It is not known how the media containing the photos became corrupted.



## Medical Exam Protocols

This section addresses medical exam tools and protocols in addition to the data collection systems and procedures (covered earlier). Based on direct observation of autopsy suites and associated facilities and procedures:

- Autopsy tools and diagnostic equipment were in generally good condition and on par with other offices. As noted elsewhere in the report the exceptions to this are the facilities and data collection systems, which are inadequate,
- Dictation is done on cassette tape rather than by digital recording. This necessitates transferring a cassette tape rather than sending a digital voice file via email,
- Transcribed reports are printed out and returned to the medical examiner. A more efficient method would be to send a MS-Word file for proofing using the track-changes feature. This would greatly reduce the iterations of the reports. An even faster method would be for the medical examiners to type up their reports in MS-Word and skip the transcription process altogether,
- Procedures for assigning autopsies seem fair and reasonable,
- Undersized tissue collection jars are occasionally used. Appropriate size jars should be used to accommodate the proper mix of tissue and



Tools of the trade for medical examiners



fixation in accordance with standards set by the College of American Pathologists,

- Diagnostic equipment is generally up-to-date. CT and MRI<sup>27</sup> scanners would be helpful, but are not an industry standard for coroners and are expensive, and
- Despite the limitations of the current facility design, the agency had generally good infection control procedures, but one or two staff persons were observed entering autopsy rooms without protective gear.

**Recommendations:**

**Recommendation C9** – The Department of the Coroner should use digital dictation equipment for recording medical exam observations. In the longer term, the department should phase out making corrections onto paper and begin correcting dictations directly onto MS-Word utilizing the track changes feature.

**Recommendation C10** – The Department of the Coroner should use appropriate size jars for tissue sampling in accordance with standards set by the College of American Pathologists.

**Recommendation C11** – The Department of the Coroner should enforce policies on wearing protective gear in the autopsy suites.



---

<sup>27</sup> Computed Tomography (CT) and Magnetic Resonance Imagery (MRI)

## Evidence and Property Custody

A proper chain of custody should clearly describe the condition in which evidence and property were found, how they were handled and all subsequent actions impacting them. The Department is responsible for ensuring that different types of physical and toxicological evidence, as well as decedents' personal property are collected and stored appropriately.

In general, the Department does a good job of following proper procedures and chain of custody for both evidence and property. Items are appropriately identified, packaged, stored and preserved as required. Both the evidence and property sections operate in secure areas with video surveillance. There is adequate space for storage (especially now with the new state-of-the-art Evidence Room).<sup>28</sup> There is adequate documentation of receipt, action and disposition of various articles and items as required. However, there are a few cases where additional effort and cooperation may be warranted as described below.



Evidence drop off boxes

There is an occasional lack of understanding and general cooperation between the Evidence Section, the Property Section and the Investigations Division, which leads to improper evidence collection and delays in evidence storage. For example there have been instances where evidence was not packaged and labeled correctly. In most cases, the Investigator corrects the identified issue in a

---

<sup>28</sup> The new evidence room was completed in October 2009.

timely manner. In other cases, the Supervising Criminalist must follow up with managers in Investigations if the issue is not corrected in a timely manner.

The Property Section also reports several situations that required them to send property back to the Investigators or notify them of necessary changes. This too has been reported through the Investigator chain of command. The problems typically encountered by the Property section include discrepancies between the property listed on the Personal Effects Inventory form (Form 2) and what was actually submitted; soiled or contaminated property; and additional property, money or drugs found. While the frequency of issues appears to be decreasing, there is a need for on-going review of property collection procedures and training to ensure a continuing reduction of identified problems.



**Recommendation:**

**Recommendation C12** – The Department of the Coroner should implement routine quality control checks of Investigator evidence and property submissions by persons outside the Investigator chain of command. The Evidence Control Supervisor and the Property Supervisor could then meet with Investigations management to go over recent problem cases and suggest corrections.

The Personal Property section retains custody of decedent's property until claimed by next of kin. However, many times the family may not be aware that property exists. The Property Custodians, as a courtesy, send a form letter to the family to

inform them that property belonging to the decedent has been collected and retained and that they may claim the property. There is no requirement for them to send this form and therefore no standard for the proper time to send it. We found that there are delays in mailing these forms, oftentimes after families have moved and therefore may not receive notification. On the date that the Auditors visited the section (October 8, 2009), they were mailing letters for property collected on June 19, 2008.<sup>29</sup> This means that there is a potential for property not being returned to the decedent's next of kin. The property would then have to be disposed of.

**Recommendation:**

**Recommendation C13** – The Department of the Coroner should send generic letters to the next of kin 30 days after notification of death is first made, in addition to the courtesy letters that are sent months later if property has not been claimed. This initial notification letter should inform the next of kin regarding procedures for claiming property and retention and disposal policies.

---

<sup>29</sup> According to the Coroner, property from an average of 200 cases is assigned for disposition by ISD each month.

## Laboratory Services

Forensic Laboratory Services operates the agency's toxicology, histology and Scanning Electron Microscope (SEM) labs. The Forensic Lab was recently re-accredited by the American Society of Crime Laboratory Directors (ASCLD). This accreditation is important for enhancing the credibility of the trial testimony offered by Coroner criminalists.

The Department does not have a replacement plan in place for laboratory devices such as gas chromatography machines. A replacement plan tracks the number, type and useful life of assets such as lab diagnostic devices so that replacements can be planned

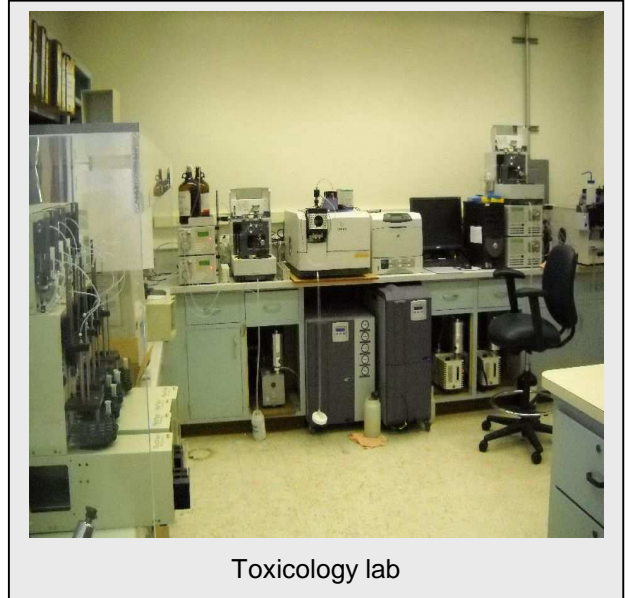

for and budgeted in an orderly manner and the operations of the Coroner are not impacted by the sudden unavailability of a device. We observed that some lab devices are nearing the end of their useful life.

### **Recommendation:**

**Recommendation C14** – The Department of the Coroner should develop an equipment replacement plan for labs and autopsy areas.

**Section D – Facilities**

The Department works out of a three-building campus at the corner of Mission Road and Marengo Street in Los Angeles. The three buildings include:

1. 1104 Mission Road (20,000 square feet), which now houses the reception desk, the notifications and identifications units, Public Services functions, the agency gift shop and records management,
2. 1102 Mission Road (16,000 square feet), which houses Administration, Investigations, IT services and equipment, and the emergency response center, and
3. 1104A Mission Road (39,000 square feet), which houses Forensic Medicine, Autopsy suites, Decedent Services, Decedent storage, Forensic Labs, Forensic Support and the Evidence unit.<sup>30</sup>

In addition, some coroner investigative staff are out-stationed in field offices in the Antelope Valley, San Fernando and the South Los Angeles area.

The 1104 Mission Road building dates from 1910, but has been recently renovated including seismic retrofitting. The building was transferred to the Coroner in 2006. The 1102 and 1104A Mission Road buildings were constructed in 1972 when the Coroner moved to its present location after operating out of the Hall of Justice downtown for several decades.

By the late 1980s, it was determined that the 1104A biological building was inadequate given the caseload growth in the intervening years and modern standards of infection control. In 2000, a facility needs assessment was

---

<sup>30</sup> Square footage figures are rounded for ease of reading. Actual square footage of the three buildings is 15,587 for 1102 Mission Road, 39,250 for 1104A Mission Road, and 19,596 for 1104 Mission Road.



conducted by an architectural firm called the SmithGroup. This study recommended a new 77,000 square foot building to replace the 1104A structure. In 2002, this study was updated by the architectural and engineering firms of RNL Design and Fuller, Coe and Associates, Inc.

RNL/Fuller, Coe assessed the current 1104A building and concluded that the existing facility was structurally sound, but that the mechanical systems (particularly fire suppression and heating, ventilation and air conditioning or HVAC) were beyond repair and not performing consistently. They also concluded that the current structure would not support expected caseload growth, and that the building was not conducive to efficient processing of cases and its layout could not adequately isolate areas with potentially infectious agents (i.e., crypts, autopsy suites) from the “clean” areas of the building (e.g., offices, labs).

We conducted a walk thru of the buildings (including the 1102 building) and observed the following:

- Many of the existing physician offices do not comply with County space standards for physicians and many are not private,<sup>31</sup>
- The ceilings, floors, and furnishings are in poor condition and reflect badly on the agency, and
- The condition of the facility is a major factor in the low work culture survey results and is probably an impediment to retention and recruiting.



---

<sup>31</sup> County space standards vary by position but call for 108 square feet for most physicians.

We also concur with the RNL/Fuller, Coe study that the autopsy floor in the 1104A building is not equipped to isolate infectious agents, is too cramped and facilitates neither efficient body intake nor autopsy processes.

The RNL/Fuller, Coe study recommended a new building of 91,000 square feet to replace the 1104A building to improve circulation, facilitate efficient processes, alleviate crypt backlogs, accommodate growth and replace obsolete mechanical systems. This would replace the existing 39,000 square foot 1104A building for a net addition of 52,000 square feet.

Neither the Smithgroup nor the RNL/Fuller, Coe recommendations were implemented due to lack of funding. In the ensuing years, the Coroner was given control of the old administration building next door at 1104 Mission Road, which added 20,000 square feet of space and allowed the public services and records functions to move out of 1104A. In 2007, a third team of architects, HMC Architects, considered the previous two studies along with the state of County finances and recommended a renovation of the 1104A biological building and the addition of a new crypt building of 5,000 square feet. In 2008, the Board of Supervisors approved the renovation. The additional 25,000 square feet of space<sup>32</sup> is 27,000 less than recommended by RNL/Fuller, Coe in 2002 but caseloads have not grown in the intervening years and crypt over-crowding has been significantly reduced. The 1104A renovation will be implemented in phases starting in 2009 and continuing through 2013. The new crypt building will be completed in mid 2010. The renovation will have the following results:

- Crypt space will be more than sufficient for current caseloads,
- Circulation and process flow will be improved but will still be less than optimal,
- HVAC will be brought up to standard,

---

<sup>32</sup> 20,000 was added with the old administration building plus the 5,000 square foot crypt addition.



- Clean and dirty areas on the service floor will be separated,
- Several new physician offices are being constructed but there will still not be enough adequately-sized private offices for all physicians, and
- Additional autopsy work areas will be added.

**Recommendation:**

**Recommendation D1** – The Department of the Coroner and the CEO should consider modifying the renovation plan to include offices for all physicians that comply with County space standards published by the CEO if they have not yet been renovated.

Finally, the renovation does not address the 1102 building which is just as unappealing and lacking in modern furnishings and improvements as the 1104A building. For example, floor coverings, ceiling panels, lights, desks, chairs and tables are all past their useful life and not up to modern standards. In our opinion, the state of 1102 has an equally negative impact on morale and retention as the 1104A building.

**Recommendation:**

**Recommendation D2** - The Department of the Coroner should obtain approval from the CEO to modify the renovation plan to include renovation of the 1102 building, including new ceilings, floors, and furnishings.

**Section E – Financial management**

In examining the Department’s adherence to its General Fund Budget, we compared actual expenses to its adopted budget for Fiscal Years 2003/04 through 2008/09. The results are summarized in the following two charts:

**Figure E1 – Actual Coroner Revenue, Expenses and NCC**

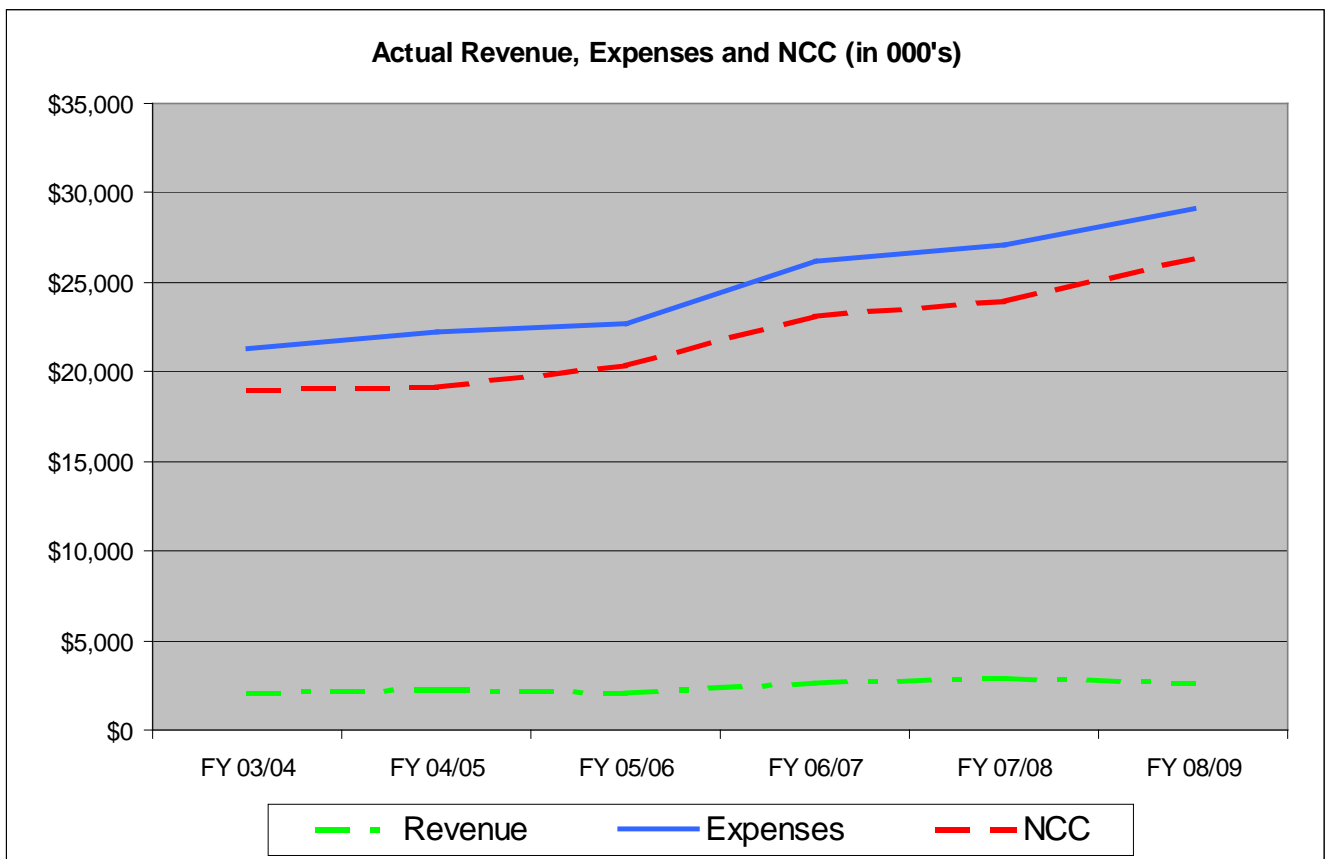

As seen in Figure E1, the Coroner is mostly financed by the County General Fund. They have been proactive and entrepreneurial in recent years in trying to expand and diversify their revenue sources particularly in sales of testing services. As

discussed later in this chapter, these efforts have had mixed success and could benefit from improved financial oversight.

**Figure E2 – Budgeted vs. Actual Expenses**

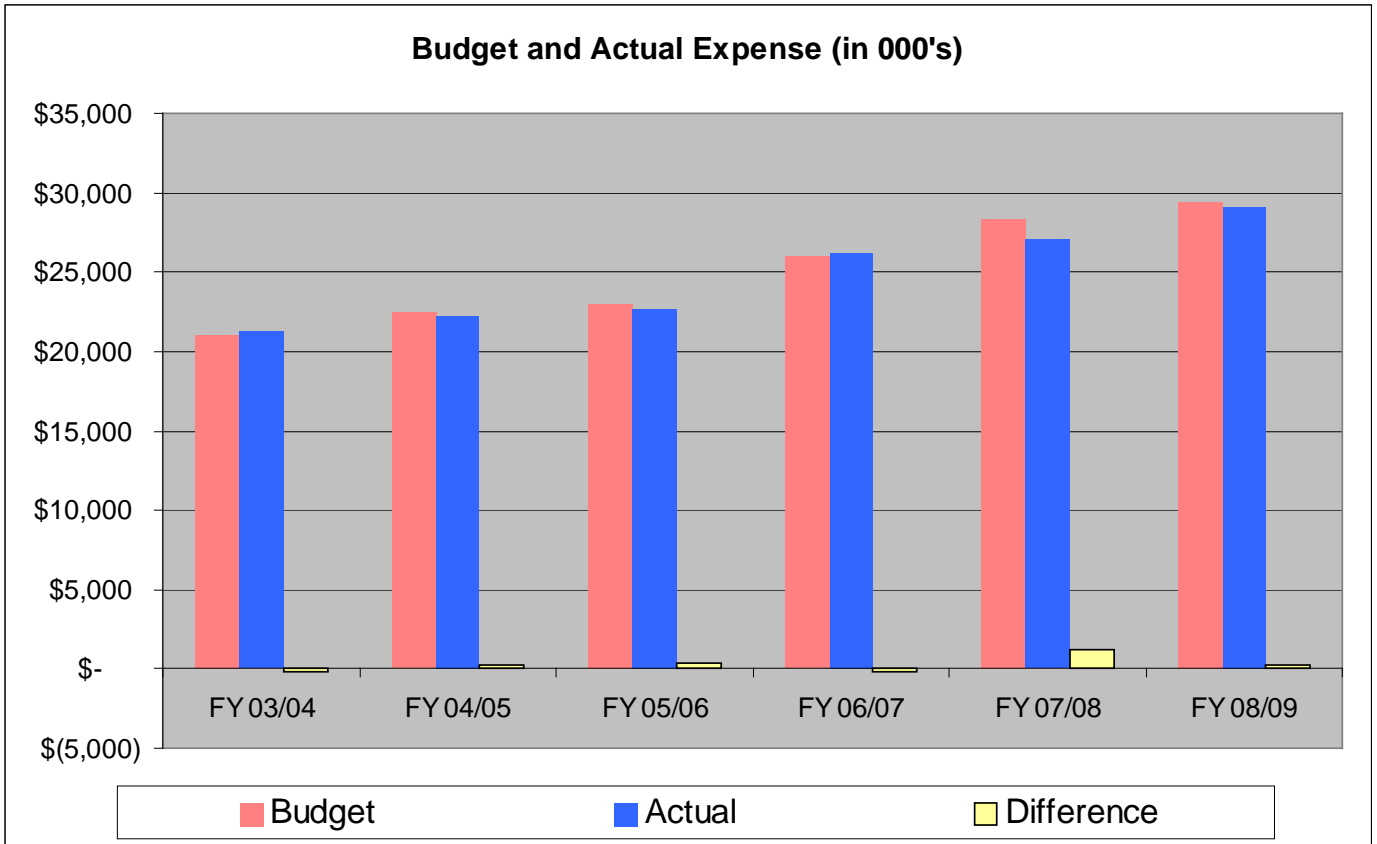

As seen in Figure E2, the Coroner has had success over the years in managing an effective budget. Historically, the Department has experienced relatively minor budget variances.

**Recommendations:** None

## Cost Recovery

### Gunshot Residue (GSR)

The Department operates a lab that analyzes chemical and tool mark<sup>33</sup> evidence using various equipment, including two Scanning Electron Microscopes (SEM). A common procedure run on the SEM is to test for gunshot residue (GSR). The presence of GSR on clothing, skin or bullet entrance wounds can help trace a weapon to the shooter, which can be persuasive evidence in criminal trials. GSR can also rule out foul play in self-inflicted, fatal gunshot wounds.

Most police agencies do not have the test volume to cost justify the purchase price of a SEM; many contract out for this service. The Los Angeles County Coroner provides testing and testimony<sup>34</sup> services to police agencies up and down the West Coast and as far away as Minnesota and is considered a leader in the field of GSR and toolmark analysis. In FY 08/09, testing and testimony services brought in \$362,000 from attorneys and law enforcement agencies.<sup>35</sup>

Based on our review of the Coroner's FY 08/09 GSR rate justification analysis,<sup>36</sup> it appears that the rate charged for tests may not have adequately covered costs. The

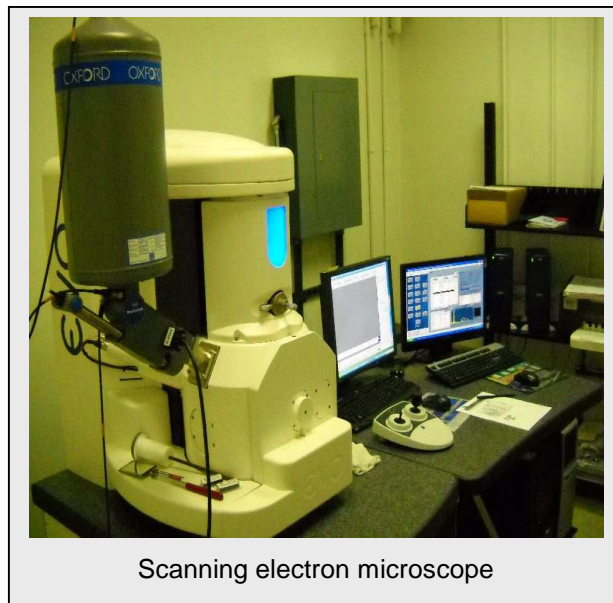

---

<sup>33</sup> A tool mark is any mark left on bone or other tissue from a weapon such as a knife, hammer, ax, etc. Using forensic techniques and equipment such as the SEM, criminalists can tie a weapon to a body through comparing the marks left on bone or tissue to the weapon.

<sup>34</sup> In addition to the test, Coroner makes the criminalists available for testimony at a fee.

<sup>35</sup> Attorneys (mostly criminal defense lawyers) request and pay for test results and depositions from criminalists. As explained later, many of these attorneys are slow payers and should be required to post retainers.

<sup>36</sup> The GSR rate analyzed was for FY 08/09 but is recalibrated annually.

analysis calculates the equipment and labor cost per hour and assumes that one test takes one hour. Of the \$463 in total costs per hour/test, the analysis shows that \$75 was for equipment. However actual equipment costs amortized over the volume of tests performed were \$140.<sup>37</sup> In addition, the analysis estimates a labor component of 2.7 hours of Coroner staff time at \$145 per hour for a total labor cost component of \$388 and then includes this amount as the labor amount on a per-hour basis (even though it's actually 2.7 hours.) The analysis also indicates the service should be charged by the hour, but Coroner staff indicated that the service is actually charged out to clients on a per-test basis – at the approved rate of \$463 for one hour of equipment and staff time. The Department's GSR rate justification analysis raises serious doubts about the actual cost recovery of this valuable service.

**Recommendation:**

**Recommendation E1** – The Department of the Coroner should recalculate the GSR testing fee to ensure it accurately reflects actual costs on a per-test basis.

**Transportation and Handling Fee (T&H)**

Government Code (GC) Section 27472 and County Code section 2.22.100 allow the Coroner to collect for transportation and handling (actually storage) of bodies from person(s) responsible for final disposition (usually the family). To make it more convenient for the families to pay, the fee of \$200 is included in the mortuary bill. The mortuaries are to then remit the \$200 to the

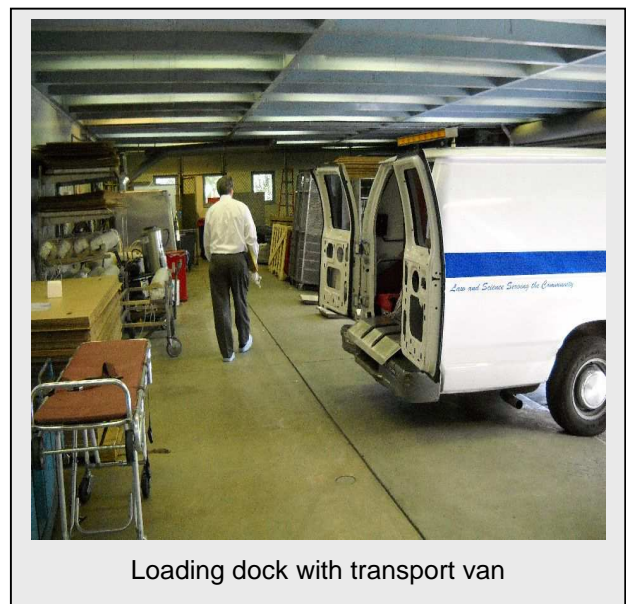

---

<sup>37</sup> Calculated by dividing the equipment costs per the rate analysis (\$73,101) by the 522, the number of GSR test performed during CY 2008, to yield a per test equipment cost of \$140.

Coroner. County Code 2.22.100 limits the fee to \$200 – the amount actually charged by the Coroner. According to the Coroner’s FY 2008/09 Transportation and Handling cost analysis, the Department incurred a cost of \$303.93 for each decedent transported resulting in a net annual loss of \$478,000 to the County for providing the service.<sup>38</sup>

**Recommendation:**

**Recommendation E2** – The Department of the Coroner should pursue an amendment to County Code section 2.22.100 so that the actual expense incurred for transportation and handling can be recovered through fees.

**Skeletons in the Closet Store**

One of the world’s most unique shopping experiences can be had at 1104 Mission Road in Los Angeles. The Department operates a gift shop called Skeletons in the Closet (Store) that sells Coroner-themed novelty gifts and apparel such as beach towels with a crime scene chalk body outline on it, toe tag refrigerator magnets, crime scene tape and other similar items. Originally the stated mission of the store was to use the net revenues from store sales to subsidize the County’s Youthful Drunk Driver Visitation Program (YDDVP).

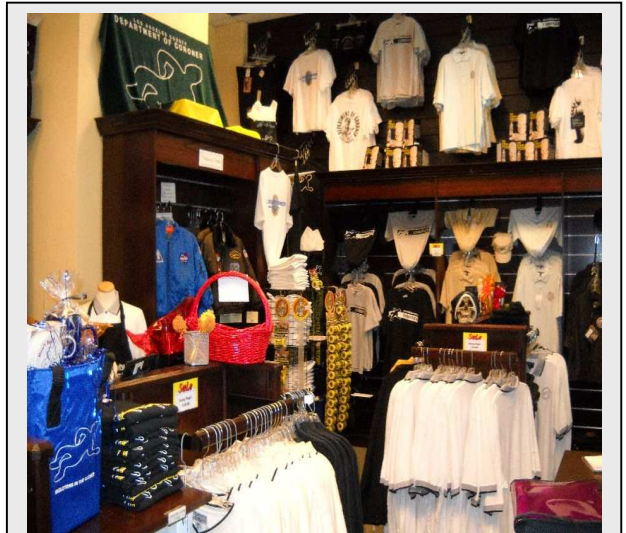

Skeletons in the Closet gift shop

Coroner records show that the store operates at a net loss of an average of \$55,000 per year

---

<sup>38</sup> Calculated by multiplying the actual number of cases billed in FY 08/09, 4,596 cases, by the unrecovered cost per case of \$104 to yield a loss of \$477,984.

over a two-year period.<sup>39</sup> In fact, the store and the YDDVP, which are operated in the same fund account, are subsidizing each other in the opposite direction. Fund balances at FYE 6/30/08 show a cumulative negative balance at the store of \$270,000 and a cumulative positive balance for YDDVP of \$250,000 over a five-year period. In other words, the YDDVP program is subsidizing the store.

A major hurdle in profitably operating the store is the location. There are no complementary traffic generators at the Coroner campus (such as other retail establishments), no advertising or signage, and parking is limited for patrons. Other than certain times of the year, the only people who see the store are those that have business at the Coroner.<sup>40</sup> Given the uniqueness and the beneficial mission of the store, a more business-like strategy should be deployed to maximize sales.

**Recommendation:**

**Recommendation E3** – The Department of the Coroner should license the manufacture and sale of Skeletons merchandise to an outside firm and/or relocate to a high traffic area (preferably one with tourists).<sup>41</sup> Combine with merchandise from other County and City agencies to reflect the colorful history of LA County government, one of the world's most fascinating urban areas.<sup>42</sup>

---

<sup>39</sup> Coroner records show a net loss of \$87,000 for the 19-month period between 1/1/07 and 7/31/08. The annualized figure is calculated by multiplying \$87,000 by 1.26 (24 divided by 19) to yield a two-year figure of \$110,000 which is then divided by two for a single year annualized amount of \$55,000. The Auditor-Controller is the source for the \$87,000 figure.

<sup>40</sup> Store merchandise is also available from the Coroner website or by mail.

<sup>41</sup> Favorable locations may include the international terminal at LAX, Hollywood Boulevard or the Melrose District.

<sup>42</sup> During the project, the auditors viewed an interesting exhibit on the history of the County District Attorney installed in the Criminal Courts Building. This type of history could also be merchandised and sold along with the Coroner merchandise in a way that captures the rich history of Los Angeles County government.



## Receivables Management

As of 10/17/09, the Coroner had accounts receivable of \$165, 284. The Department handles accounts receivable in conjunction with Auditor Controller (AC) Shared Services. The following table and chart show the status of these receivables.

**Table E1 – Outstanding Receivables as of 10/17/09**

Service Description	<30	31-60	61-90	>91	Total receivables
Transportation & Handling	\$ 6,600	\$ 5,069	\$ 5,200	\$ 52,514	\$ 69,383
Veteran Burials	\$ -	\$ 1,500	\$ 2,250	\$ 3,750	\$ 7,500
Lab Fees (not GSR)	\$ -	\$ 2,039	\$ -	\$ -	\$ 2,039
GSR Testimony	\$ 1,405	\$ 3,345	\$ -	\$ 19,190	\$ 23,939
GSR Analysis	\$ 12,064	\$ 2,784	\$ -	\$ 1,412	\$ 16,260
Document Sales	\$ -	\$ 23,214	\$ -	\$ 4,049	\$ 27,263
Statistical services	\$ -	\$ 643	\$ 126	\$ 204	\$ 973
Tissue bank contract	\$ 7,820	\$ 7,155	\$ -	\$ -	\$ 14,975
Other services	\$ -	\$ 1,730	\$ 297	\$ 925	\$ 2,952
<b>Total</b>	<b>\$ 27,888</b>	<b>\$ 47,479</b>	<b>\$ 7,873</b>	<b>\$ 82,044</b>	<b>\$ 165,284</b>



**Figure E3 – Outstanding Receivables**

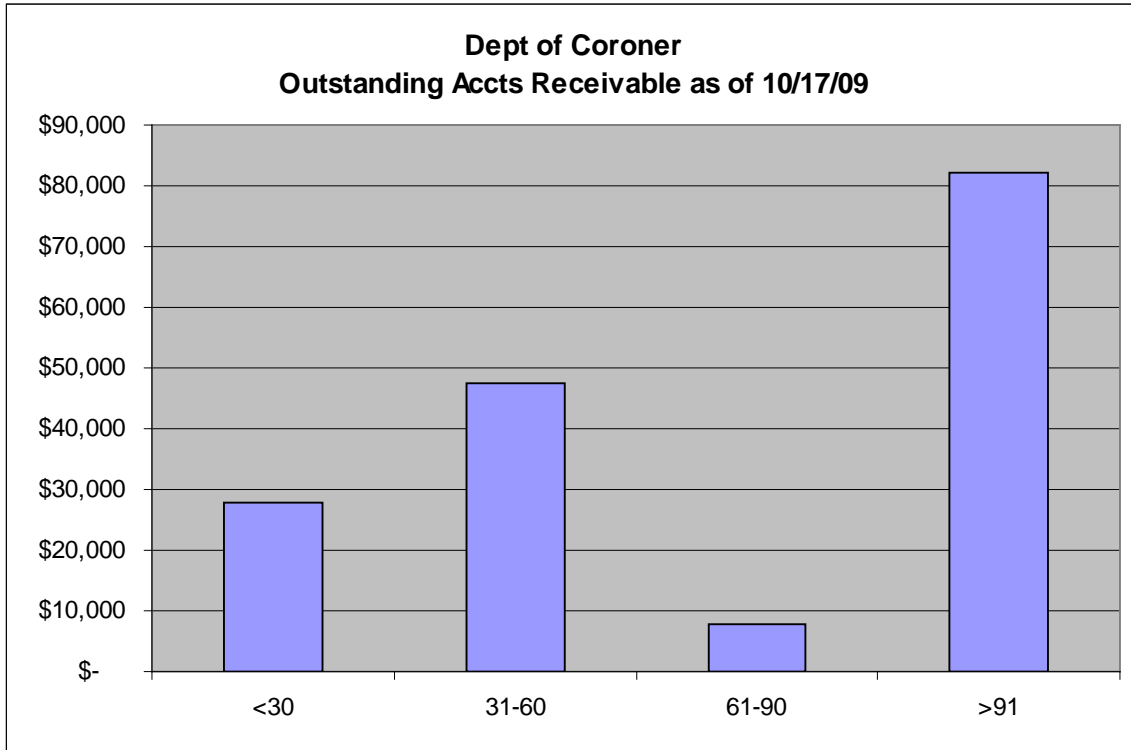

As seen in the table and chart, 50% of the receivables, or \$82,000, are more than 90 days in arrears. Of this amount, \$53,000 was for transportation and handling of decedents and is owed by several mortuaries in the County. Nineteen thousand dollars is owed by law enforcement agencies and attorneys for GSR testimony.

County policy on receivables is covered in Section 10 of the County Fiscal Manual (CFM). The Department’s accounts receivable have been handled by the Auditor-Controller’s Shared Services Division, except for Transportation and Storage and Veterans Burials.<sup>43</sup> CFM Section 10.1.3 encourages agencies to age accounts receivables to identify those outstanding for 30, 60 and 90 days and to ensure future services are not rendered (except services mandated by legal authority<sup>44</sup>)

<sup>43</sup> Transportation and Storage receivables were referred to the Treasurer and Tax Collector on 10-14-09.

<sup>44</sup> Transportation and storage services may not be denied for non-payment according to H&S Code 7053.

until past due amounts are paid. As of 10/17/09, the Coroner did not age its Transportation and Handling or Veterans Burials accounts receivables.

Section 10.2.2 states that accounts delinquent for a period of 60 days from the accrual date, excluding governmental agencies,<sup>45</sup> should be referred to the Treasurer and Tax Collector (TTC) for collection. Of the \$82,000 in over-90-days receivables, only a small fraction has been referred to the TTC for collection.

**Recommendations:**

**Recommendation E4** – The Department of the Coroner should age accounts receivable on a monthly basis to identify those outstanding for over 30, 60 and 90 days and to ensure future services are not rendered (except those mandated by legal authority) until past due amounts are paid.

**Recommendation E5** – The Department of the Coroner should require a retainer or payment up front for clients who demonstrate a history of non-payment or slow payment. This would apply primarily to law firms that pay for Coroner testimony.

**Recommendation E6** – The Department of the Coroner should refer delinquent accounts (except for receivables from municipalities) to the TTC for collections per County Fiscal Manual Section 10.2.2 guidelines.

---

<sup>45</sup> The exclusion for government agencies is addressed in CFM Section 10.2.3.

## DNA Testing Lab

The Department currently outsources its DNA testing needs to commercial labs, and in certain cases, the Department of Justice (DOJ). However, commercial labs are expensive and tend to have difficulty handling skeletonized remains typically encountered by the Coroner. Further, DOJ handles DNA requests from agencies all over the state, which results in an average turnaround time of nine months. In the past, the Coroner has also sent several homicide cases for DNA testing to the County Sheriff's crime lab but identifying Coroner remains proved to be a low priority and these cases were ultimately not processed. This created a delay in the identification of unidentified bodies and notification of next of kin. These cases were eventually sent to a commercial lab for testing.

The Department is presently developing its own lab to enhance its identification process and further expand its scientific capabilities. This laboratory would be used for identifying Coroner cases, paternity testing, and potentially for postmortem genetic testing for cause of death determination in sudden unexpected deaths.<sup>46</sup> An accredited DNA laboratory also has the potential to raise extra revenue by selling testing services to outside agencies, private business and members of the public.

The Department provided a Business Plan that discusses the need for a lab, potential pricing and marketing strategies, operating standards, personnel needs, and includes a cost estimate of \$1.6 million over a three-year time horizon. A little less than one-half of that would be for consulting services to get the lab up and running. The Department has been given a grant/loan by the Los Angeles County Quality and Productivity Commission to provide initial capital for the lab. While the plan does cover many of the basic business plan elements, it should be enhanced

---

<sup>46</sup> Some families want paternity testing performed for children prior to burying their deceased family member.

to address issues of reasonable projections such as pricing, unit costs, competitive positioning, marketing and revenue/profitability:

- Pricing: Although the plan projects potential fees of \$600-\$900 per test, it does not indicate a projected cost per test. While the plan also indicates that this is common pricing for this type of analysis, the Competitive Matrix Chart in the plan indicates that two of three competitors offer the service for free, and a third provider charges \$200 and up,
- Demand and revenue projections: current demand, the number of potential customers, or an estimate of the size of the market.
- Profitability Analysis: Given the cost and revenue, whether the service will bring in enough revenue to cover operating expenses,
- Projected market share, and
- Cost or effectiveness of the proposed advertising.

**Recommendation:**

**Recommendation E7** – The Department of the Coroner should work with the CEO to ensure that the DNA Lab Business Plan includes reasonable demand and financial projections, including financial viability to sustain the lab beyond the three year timeline.

**Section F – Security**

Safety and security at the Coroner is important for many reasons including:

- Confidentiality of Coroner records has to be protected until the information becomes part of the public record,
- Evidence used for criminal investigations needs to be safeguarded,
- Privacy of decedents and their family members needs to be protected, and
- Coroner employees need to have a safe work environment protected from members of the public in the field or who come to the Coroner’s Office and may be upset and potentially pose a threat.

The Department has implemented the following security measures in response to these needs:

- The Department updated a policy for dealing with high profile decedents in May 2009 (superseding a 1992 policy) that covers all aspects of data security, facility access, and handling public inquiries,
- The Department enforces laws and policies prohibiting use of cameras,<sup>47</sup>



Reception area in the old admin building (1104 Mission Road)

---

<sup>47</sup> Code of Civil Procedure section 129 and Coroner policy number 105 – Security for High Profile Cases

- The Department monitors most areas of the campus using video cameras, and
- Most secure areas were either guarded by the receptionist or secured by locked doors.

## Employee Security

Our observations showed:

- Policies requiring ID badges are not always enforced. As a result, employees cannot be easily differentiated from individuals who should not have access to Coroner facilities,<sup>48</sup>
- Access to buildings is based on traditional metal keys, which are easy to duplicate or lose, instead of electronic card keys which are much more secure. Card keys also record and time-stamp who enters and exits secure areas providing a useful audit trail in case of theft or other criminal activity. The record can help to catch thieves and criminals that enter secure areas (such as where the drugs are stored) and can also acts as a deterrent

Policies requiring constant, physical supervision of community service and work-release workers<sup>49</sup> are not fully enforced, despite Work Release and Community Based Alternatives to Custody (CBAC) and Court Referred Volunteer (CRV) program policies that explicitly state that “supervision MUST be provided at all times.” Coroner employees expressed concerns for their safety while working along side these individuals. Several employees indicated during interviews that one community service worker came to work armed. According to the

---

<sup>48</sup> This objective may present challenges during a time of construction and renovation.

<sup>49</sup> These workers perform janitorial services at the Coroner facility.

incident report, a handgun was found on the worker, law enforcement officials were called and they removed the individual from the premises, and

- Numerous incidents involving threats to Coroner staff (i.e., by members of the public) were recounted in interviews, focus group feedback and in phone calls to the audit team. However, many of these incidents were not documented in formal incident reports. A better documentary record of incidents where the security of Coroner staff was compromised would provide management and County policy makers with the necessary support for making decisions on enhancing security and protection for Coroner staff.

**Recommendations:**

**Recommendation F1** - The Department of the Coroner should enforce a strict ID badge policy for employees.

**Recommendation F2** - The Department of the Coroner should install an up-to-date electronic card key access system in all buildings.

**Recommendation F3** - The Department of the Coroner should hire custodial staff or contract with a provider of custodial service and eliminate the use of community service and work-release workers to perform custodial duties.

**Recommendation F4** – The Department of the Coroner should judiciously monitor and document security incidents for a period of two years and analyze the findings to determine what, if any, additional security measures should be implemented to ensure a safe working environment for Coroner staff.



## Cadaver-Detection Dog

The Department has a cadaver-detecting dog (Indiana Bones), selectively trained and maintained, to search and find human remains. The dog has successfully proven its ability to locate cadavers in a variety of terrain and even underwater. When off duty, the dog resides in a portable kennel in the basement of the 1102 building. The dog's presence in the office is a continuing source of anxiety for many of the Department's staff. Since the dog was obtained, there have been four documented incidents involving Coroner employees and two of the four incidents involved a bite.<sup>50</sup> The dog appears to be a high-strung animal with an uneven disposition. The dog engages in regular training to hone and maintain its detection skills, and has undergone socialization training to moderate its antisocial personality. Neither employee safety nor building security should be at risk to a high strung and temperamental dog.

### **Recommendation:**

**Recommendation F5** – The Department of the Coroner should obtain a qualified trainer to help modify the dog's temperament and evaluate and develop handling and care procedures (e.g., socialization, leash and boarding requirements, ect.). If incidents such as attacks and bites continue after the dog receives behavioral training, consider kenneling the dog at an offsite location during the day.

---

<sup>50</sup> Though not required by law, in the incidents where the dog bit humans, the incidents were not reported to Animal Control nor was the dog quarantined per the Coroner. There was one additional undocumented incident involving a bite that occurred out in the field but this is based on verbal information only.

## Data Security

The Department maintains case and decedent data in three primary databases:

1. Coroner Medical Examiner (CME) system – a case management system produced by VertiQ (discussed in greater detail in the Work Processes section). This system contains information on death investigations, next of kin, evidence, cause of death, the condition of bodies, etc.,
2. Tox DB – a homegrown toxicology lab database produced in MS-Access. This database contains toxicology lab test requests and results, and
3. Electronic Death Registration System (EDRS) – a statewide system that stores death certificates. This system is owned and operated by the State Department of Health Services.

All three systems are password protected. Once logged on to any of the three systems, any authorized Coroner employee has access to case information, death certification information, case notes, etc. The exception to this is any case put on “security hold.” Security hold cases are restricted to only a few Coroner employees and are typically used for high-profile decedents (e.g., celebrities) or cases involving ongoing police investigations.

Coroner employees must sign a user agreement as a condition for obtaining a password. This agreement prohibits sharing of computerized data with outside individuals or organizations unless directed by management and limits use of data to business purposes only. Violating the user agreement is punishable by disciplinary action up to and including discharge.

Most Coroner case file information becomes part of the public record once the death certificate is registered with the State. Exceptions to this include personal property documentation, any document that reveals the identity of next of kin,

medical examiner notes, photos and medical records. Death certificates are public records even before cause of death has been determined and are available from the County Recorder and the Department of Public Health, though next of kin information is kept private.<sup>51</sup> We identified three security flaws with regards to Coroner files:

1. Two documents, the medical evidence inventory form and the investigation narrative, are not protected by a security hold. Both these documents contain potentially sensitive information about a death scene, the condition of the body, medications that were nearby, etc. The current systems' lack of a security hold feature for these particular documents can expose the data to unauthorized release,
2. CME does not prevent a record from being altered by someone other than the author of the record. For example, the cause of death can be changed by someone other than the medical examiner who examined the body, and
3. The Tox DB has no security hold feature that would prevent the unauthorized release of toxicology test data.

As indicated in the Case Management System section of this report, the Coroner is implementing Documentum, a new Countywide standard for document management. As part of Documentum, the Coroner will implement a replacement Case Management System that would support a more aggressive workflow approach than CME. In addition, a replacement system would address the current CME security vulnerabilities noted above.

**Recommendations:**

**Recommendation F6** – As indicated in Recommendation C5, the Coroner should continue its plans to implement a replacement Case Management

---

<sup>51</sup> Before cause of death is determined, a death certificate is in deferred status to permit burial of the remains. Once the cause is determined, the certificate becomes final.

System in Documentum. In the interim, the Department of the Coroner should continue working with a private vendor to correct the Security Hold vulnerabilities in CME.

**Recommendation F7** – As indicated in Recommendation C5, the Coroner should continue its plans to implement a replacement Case Management System in Documentum. In the interim, the Department of the Coroner should work with a private vendor to implement record-level security in CME so that only the author of a record can alter data.

**Recommendation F8** – The Department of the Coroner should replace the MS-Access-based Tox database with a toxicology lab module that is integrated into the case management system.

**Section G – Strategic Management**

Senior management at the Coroner has integrated a strategic planning process into their executive management practices. The process incorporates many important elements, including: planning meetings, production of a strategic plan document, and regular updates to their plan. The Department Strategic Plan is a “living” document, routinely referred to at the executive management level and updated as circumstances change and goals are accomplished. The plan is integrated with Countywide strategic planning goals.

The Department effectively integrates day-to-day operational goals into its planning process, acknowledging that many ongoing, routine activities are essential to strong strategic management. This indicates that the plan is grounded in reality and is more likely to be implemented than strategic plans that limit their focus to big picture aspirations, which are difficult to measure.

The following table summarizes the extent to which the Coroner implements an effective strategic planning process. Criteria are evaluated as a strength when they are met most of the time, adequate when they are met some of the time, and needs improvement when they are met rarely, partially, or not at all.

**Table G1 – Strategic Planning Assessment Summary**

<b>Strategic Planning Criteria</b>	<b>Strength</b>	<b>Adequate</b>	<b>Needs Improvement</b>
Organization of plan	Plan is well organized and easy to understand		
Continuity with Countywide strategies	Plan is very congruent with Countywide strategy		
Identification of the “right” strategic priorities.		Strategies are not prioritized though they have target dates	
Impact of the external environment and the expectations of important stakeholders.	Sensitive to needs of external stakeholders		
Communication of strategic priorities and goals throughout the organization, as well as a communications process directed at Coroner staff and external stakeholders to build support for plan implementation.			No systematic effort to instill strategic plan in ongoing operations
Relevant and measurable goals that are based on empirical data versus impressions or aspirations.		Based on identified needs	
Adequate detail of what needs to be accomplished, including individual accountability, outcomes, and due dates to ensure that implementation can proceed without excessive interpretation.		Plan could benefit from an action plan	
Indicators to monitor implementation and report on progress toward goals.			Most goals lack indicators to measure progress

**Recommendations:**

**Recommendation G1** - The Department of the Coroner should prioritize goals to allocate resources more effectively. Goals should be analyzed in terms of importance and ease and/or cost of implementation. For example, goals can be plotted on a graph to understand the trade-offs between importance and cost (see figure G1).

**Figure G1 – Strategic Goals Matrix**

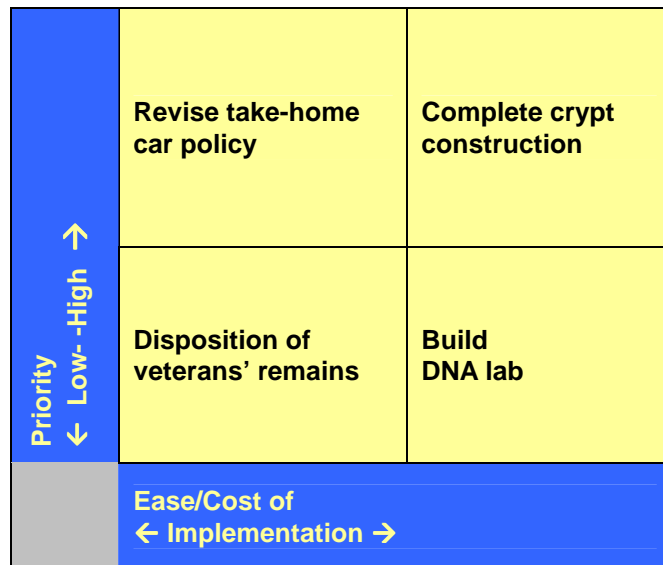

**Recommendation G2** - The Department of the Coroner should prepare Action Plans for each goal, detailing timeframes and due dates, assigning accountability, describing standards, and defining specific measurements.

**Recommendation G3** - The Department of the Coroner should track progress of plan implementation with detailed accountability at the appropriate management or supervisor levels below the bureau chief.



## ***Appendices***

Appendix A – Glossary of acronyms

Appendix B – Physician staffing projection

Appendix C – Process maps

Appendix D – Benchmarking charts

Appendix E – Recommendation table

**Appendix A – Glossary of Acronyms**

<b>Acronym</b>	<b>Definition</b>
ACGME	Accreditation Council for Graduate Medical Education
ASCLD	American Society of Crime Laboratory Directors
CME	Coroner Medical Examiner (system)
EDRS	Electronic Death Registration System
CT	Computed Tomography
DHS	Department of Health Services (LA County)
GC	Government Code
GSR	Gun Shot Residue
HVAC	Heating, Ventilation, Air Conditioning
ISD	Internal Services Department (LA County)
LAPD	Los Angeles Police Department
MRI	Magnetic Resonance Imaging
NAME	National Association of Medical Examiners
NCC	Net County Cost
SEM	Scanning Electron Microscope
Tox DB	Toxicology Data Base
T&TC	Treasurer and Tax Collector (LA County)
YDDVP	Youthful Drunk Driver Visitation Program

**Appendix B – Physician Staffing Projections**

Title	Years of County Service										
	Current	1 2010	2 2011	3 2012	4 2013	5 2014	6 2015	7 2016	8 2017	9 2018	10 2019
Senior Physician	32	33	34	35	36	37	38	39	40	41	42
Physician Specialist	29	30	31	32	33	34	35	36	37	38	39
Physician Specialist	25	26	27	28	29	30	31	32	33	34	35
Physician Specialist	25	26	27	28	29	30	31	32	33	34	35
Physician Specialist	24	25	26	27	28	29	30	31	32	33	34
Senior Physician	22	23	24	25	26	27	28	29	30	31	32
Physician Specialist	22	23	24	25	26	27	28	29	30	31	32
Senior Physician	21	22	23	24	25	26	27	28	29	30	31
Physician, MD	19	20	21	22	23	24	25	26	27	28	29
Physician Specialist	19	20	21	22	23	24	25	26	27	28	29
Physician Specialist	17	18	19	20	21	22	23	24	25	26	27
Physician Specialist	17	18	19	20	21	22	23	24	25	26	27
Physician Specialist	16	17	18	19	20	21	22	23	24	25	26
Physician Specialist	15	16	17	18	19	20	21	22	23	24	25
Physician Specialist	14	15	16	17	18	19	20	21	22	23	24
Physician, MD	13	14	15	16	17	18	19	20	21	22	23
Physician Specialist	11	12	13	14	15	16	17	18	19	20	21
Physician Specialist	11	12	13	14	15	16	17	18	19	20	21
Physician Specialist	11	12	13	14	15	16	17	18	19	20	21
Physician Specialist	8	9	10	11	12	13	14	15	16	17	18
Physician Postgraduate	3	4	5	6	7	8	9	10	11	12	13
Physician Postgraduate	2	3	4	5	6	7	8	9	10	11	12
Physician Specialist	2	3	4	5	6	7	8	9	10	11	12
Physician Postgraduate	0	1	2	3	4	5	6	7	8	9	10
<b>Physician Count (note 1):</b>	<b>24</b>	<b>22</b>	<b>22</b>	<b>22</b>	<b>22</b>	<b>20</b>	<b>19</b>	<b>19</b>	<b>17</b>	<b>16</b>	<b>16</b>
Less: replacement for chiefs		1	1	1	1	2	2	2	2	2	2
Sub-total:	24	21	21	21	21	18	17	17	15	14	14
Net physician recruiting (note 2):				1	1	1	1	1	2	2	2
Net physician count:	24	21	21	22	22	19	18	18	17	16	16
10 year average autopsies/exams (note 3):	5911	5911	5911	5911	5911	5911	5911	5911	5911	5911	5911
Autopsies/exams per physician:	246	281	281	269	269	311	328	328	348	369	369
Years over NAME standard (note 4):		X	X	X	X	X	X	X	X	X	X
Physician staffing shortfall (note 5):		2.6	2.6	1.6	1.6	4.6	5.6	5.6	6.6	7.6	7.6
Mean tenure at Coroner:	16										
Note 1: Assumes that physicians leave County employment at 30 years of service.											
Note 2: Assumes a net gain of one physician every 5 years based on net of recruitment/departures for 2004-09.											
Note 3: 10 year average for 1999-2008. Counts exams as one-half of an autopsy per NAME counting convention.											
Note 4: X notes years where per physician workload exceeds NAME standard of 250 autopsies/exams per year per physician.											
Note 5: Assumes maintaining NAME standard of 250 autopsies/exams per physician.											

**Appendix C – Process Maps**

LA Coroner Mgmt Audit  
Clearance Case  
Page 1 of 1  
Created 9/29/09  
Edited 10/5/09

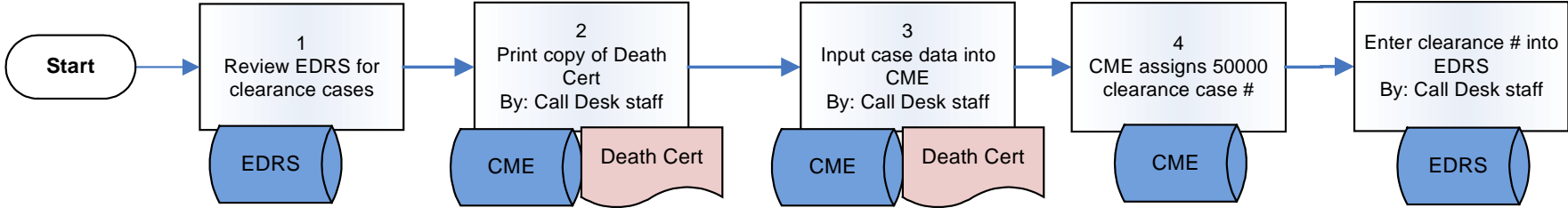

**Acronym Key**  
CME = Coroner's Medical Examiner System  
EDRS = Electronic Death Registration System

# MANAGEMENT AUDIT OF THE LOS ANGELES COUNTY CORONER

LA Coroner Mgmt Audit  
 Field Call  
 Page 1 of 1  
 Created 9/29/09  
 Edited 10/12/09

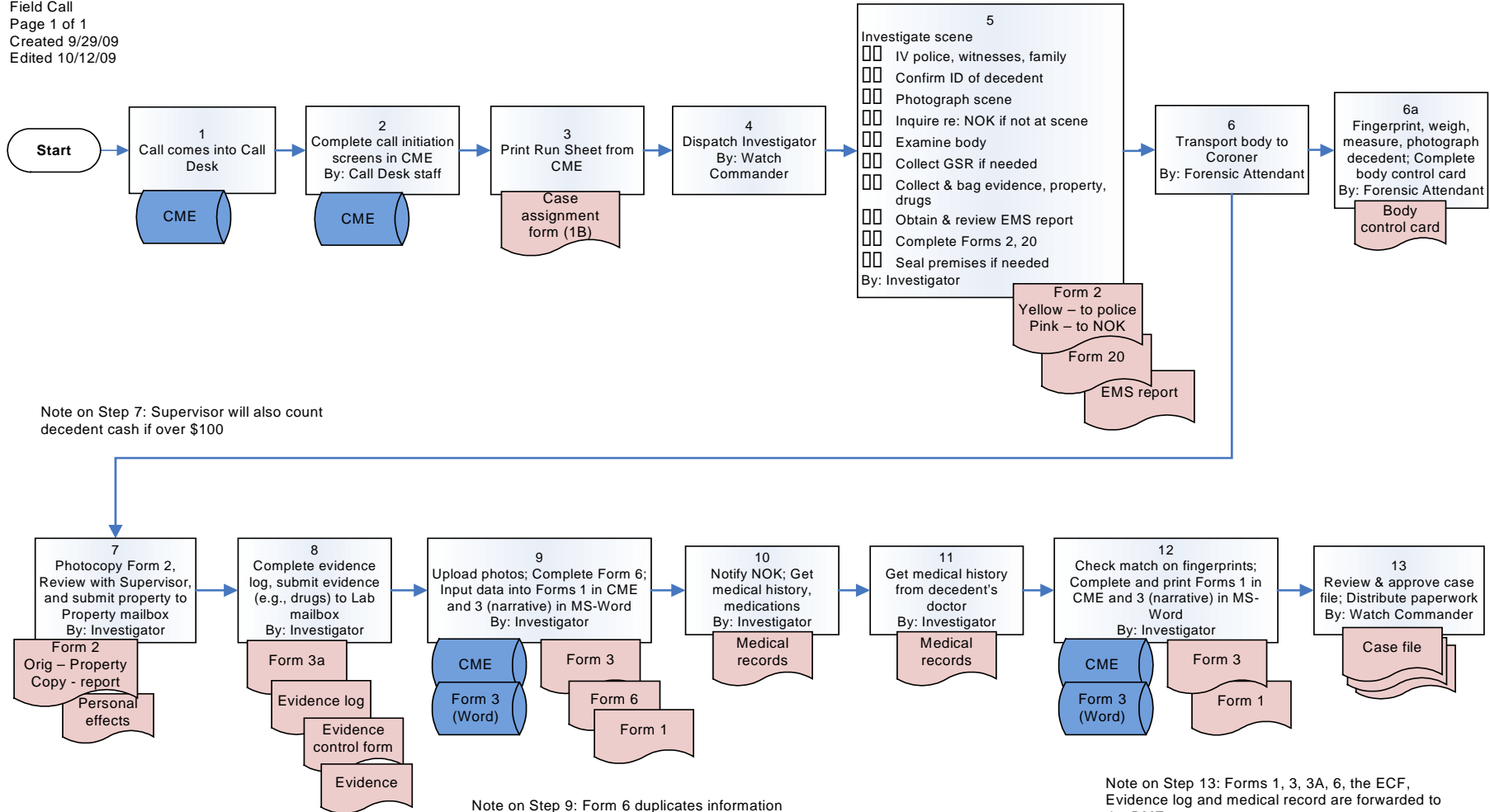

**Acronym Key**

- CME = Coroner's Medical Examiner System
- DC = Death Certificate
- DME = Deputy Medical Examiner
- EMS = Emergency medical services
- Form 3a = Evidence Control Form
- Form 1 = Case Report
- Form 2 = Personal Effects inventory
- Form 3 = Investigation Narrative
- Form 6 = Prelim Exam Report
- Form 20 = Body diagram
- NOK = Next of Kin

# MANAGEMENT AUDIT OF THE LOS ANGELES COUNTY CORONER

LA Coroner Mgmt Audit  
 Mortuary Sign-out  
 Page 1 of 1  
 Created 9/30/09  
 Edited 10/5/09

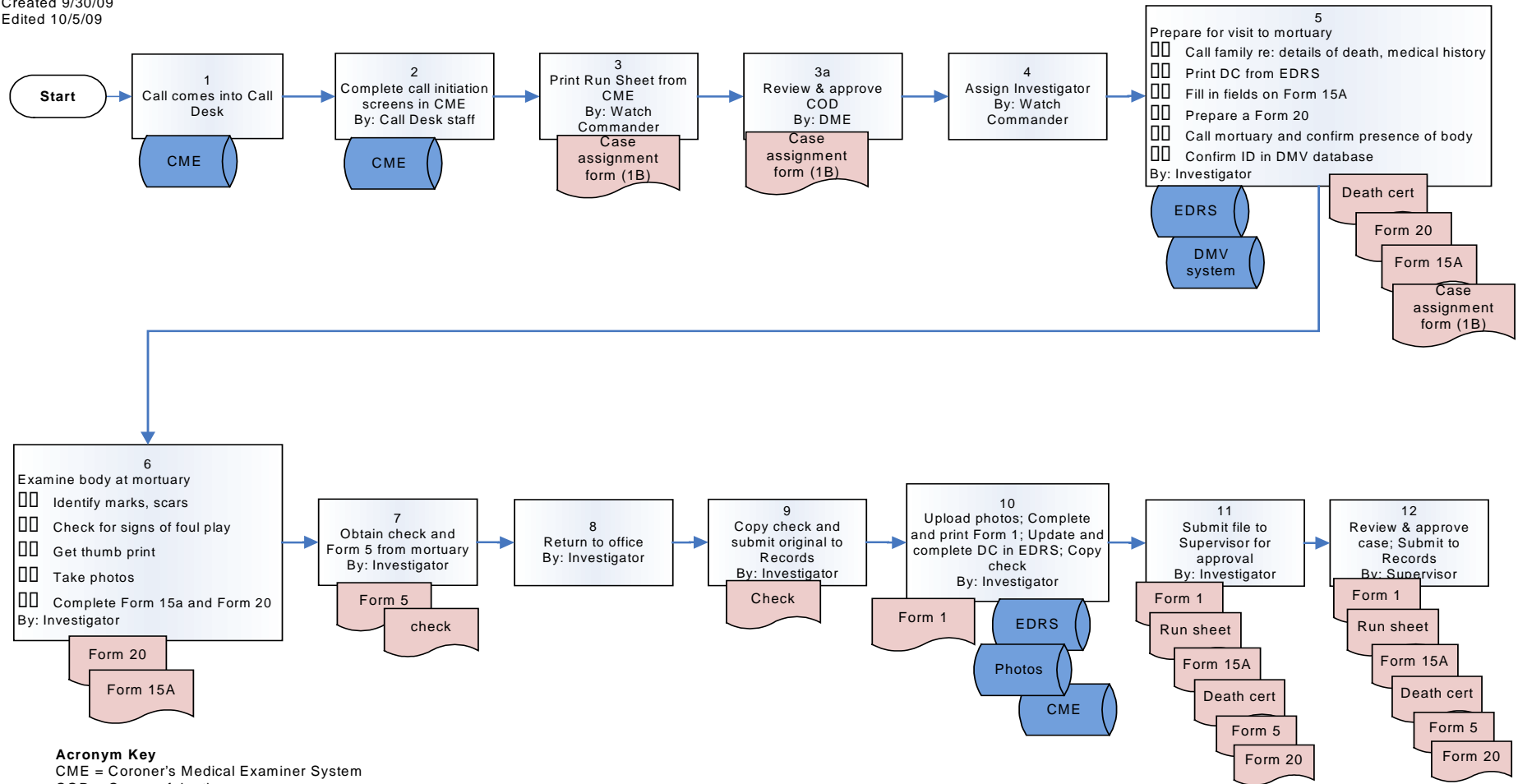

**Acronym Key**

- CME = Coroner's Medical Examiner System
- COD = Cause of death
- DC = Death Certificate
- DME = Deputy Medical Examiner
- DMV = Dept of Motor Vehicles
- EDRS = Electronic Death Registration System
- Form 1 = Case Report
- Form 3 = Investigation Narrative
- Form 5 = Order for Release
- Form 15a = Medical Report – Field Investigation
- Form 20 = Body diagram
- NOK = Next of Kin

LA Coroner Mgmt Audit  
 Medical Examination Scheduling  
 Page 1 of 1  
 Created 10/1/09  
 Edited 10/5/09

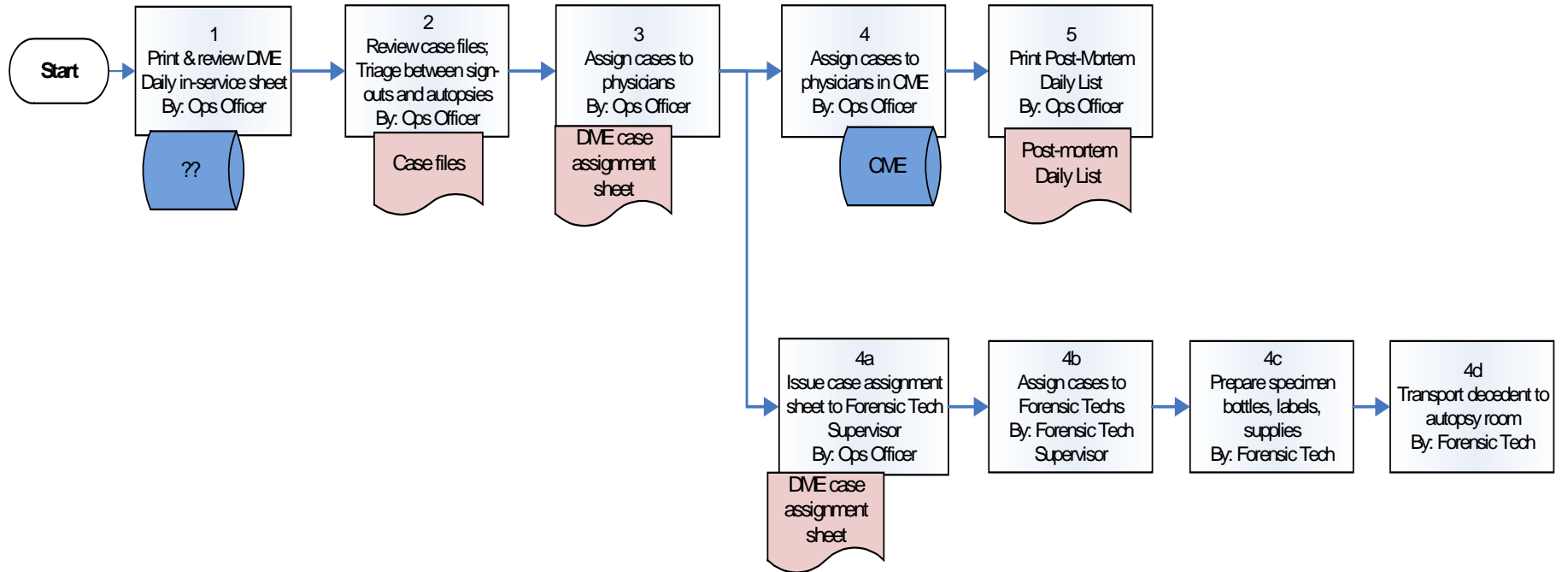

**Acronym Key**

CME = Coroner's Medical Examiner System  
 DME = Deputy Medical Examiner



# MANAGEMENT AUDIT OF THE LOS ANGELES COUNTY CORONER

LA Coroner Mgmt Audit  
 Medical Examination-Sign Out / Lab Test  
 Page 1 of 1  
 Created 10/11/09  
 Edited 10/14/09

Note: Form 15 can be generated in CME  
 – use workflow to distribute in agency

Note on step 5: Form 15 multi-part distro  
 Goldenrod – DME  
 Yellow – Toxicology  
 White – File  
 Pink - File

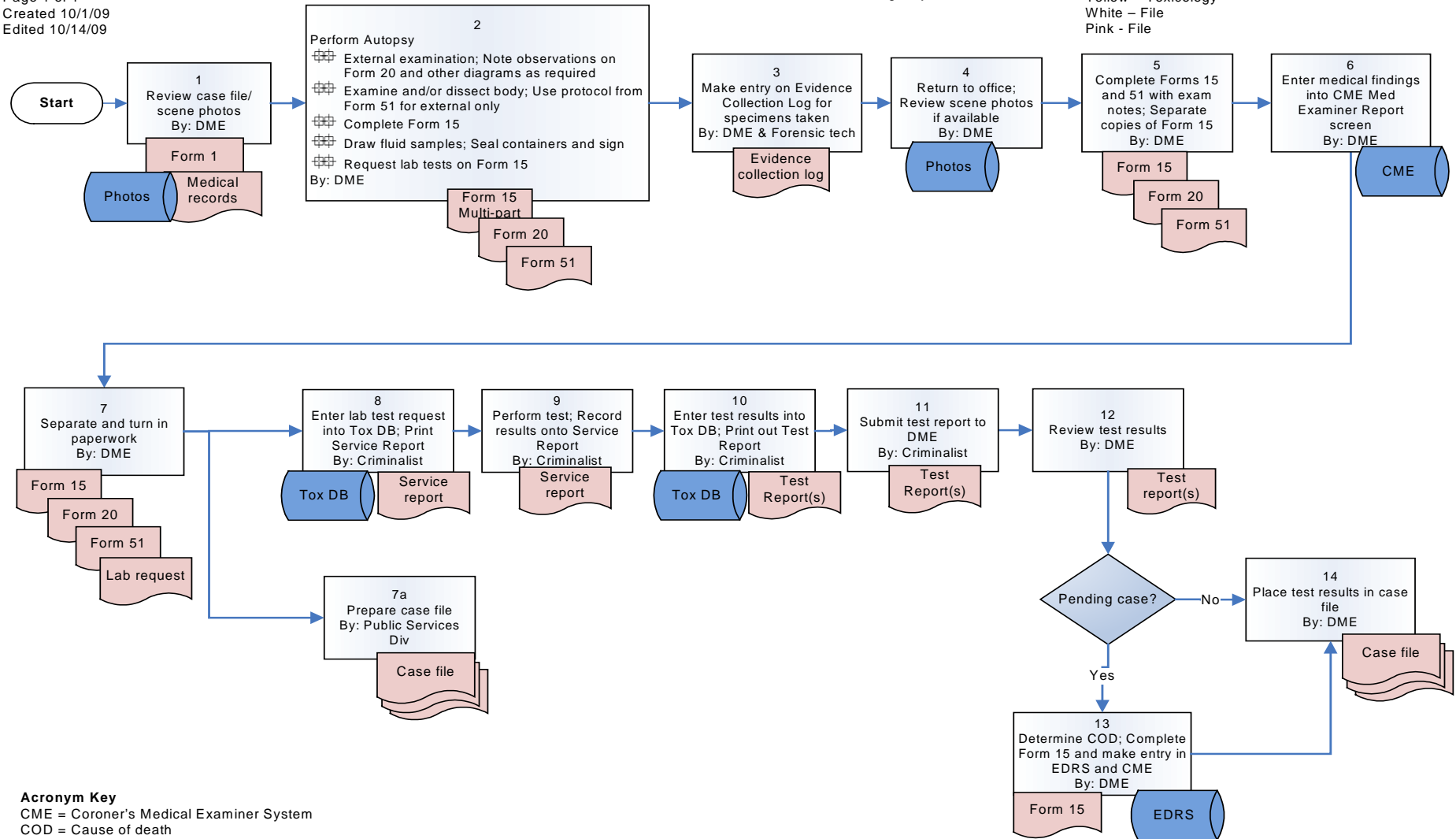

**Acronym Key**

- CME = Coroner's Medical Examiner System
- COD = Cause of death
- DC = Death Certificate
- DME = Deputy Medical Examiner
- EDRS = Electronic Death Registration System
- Form 15 = Medical Report
- Form 20 = Body diagram
- Form 51 = Examination Protocol

# MANAGEMENT AUDIT OF THE LOS ANGELES COUNTY CORONER

LA Coroner Mgmt Audit  
 Medical Examination-Autopsy / Lab Test  
 Page 1 of 1  
 Created 10/1/09  
 Edited 10/14/09

Note: Form 15 can be generated in CME  
 - use workflow to distribute in agency

Note on step 4: Form 15 multi-part distro  
 Goldenrod - DME  
 Yellow - Toxicology  
 White - File  
 Pink - File

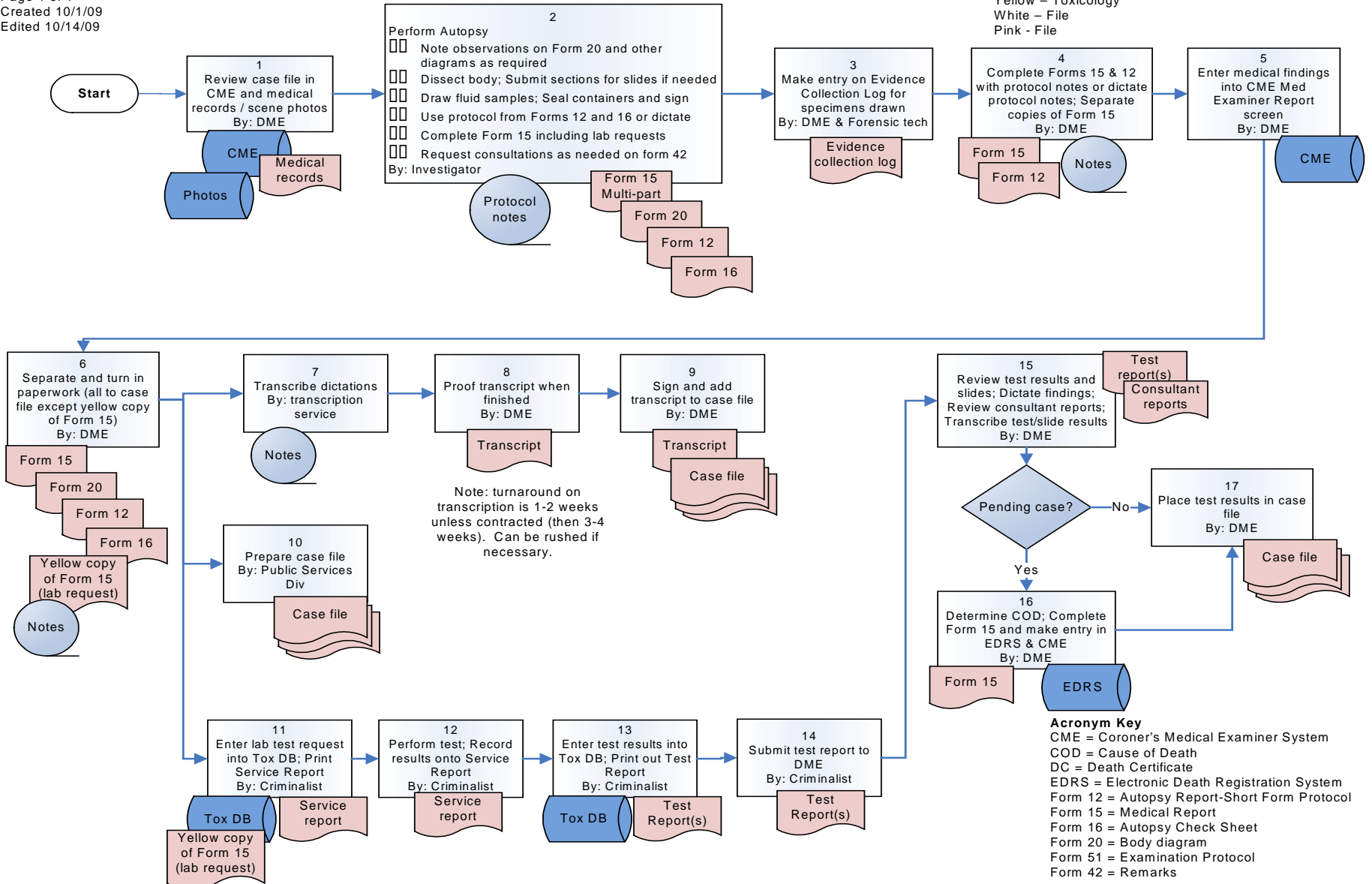

LA Coroner Mgmt Audit  
 Law Enforcement Document Request  
 Page 1 of 1  
 Created 9/30/09  
 Edited 10/5/09

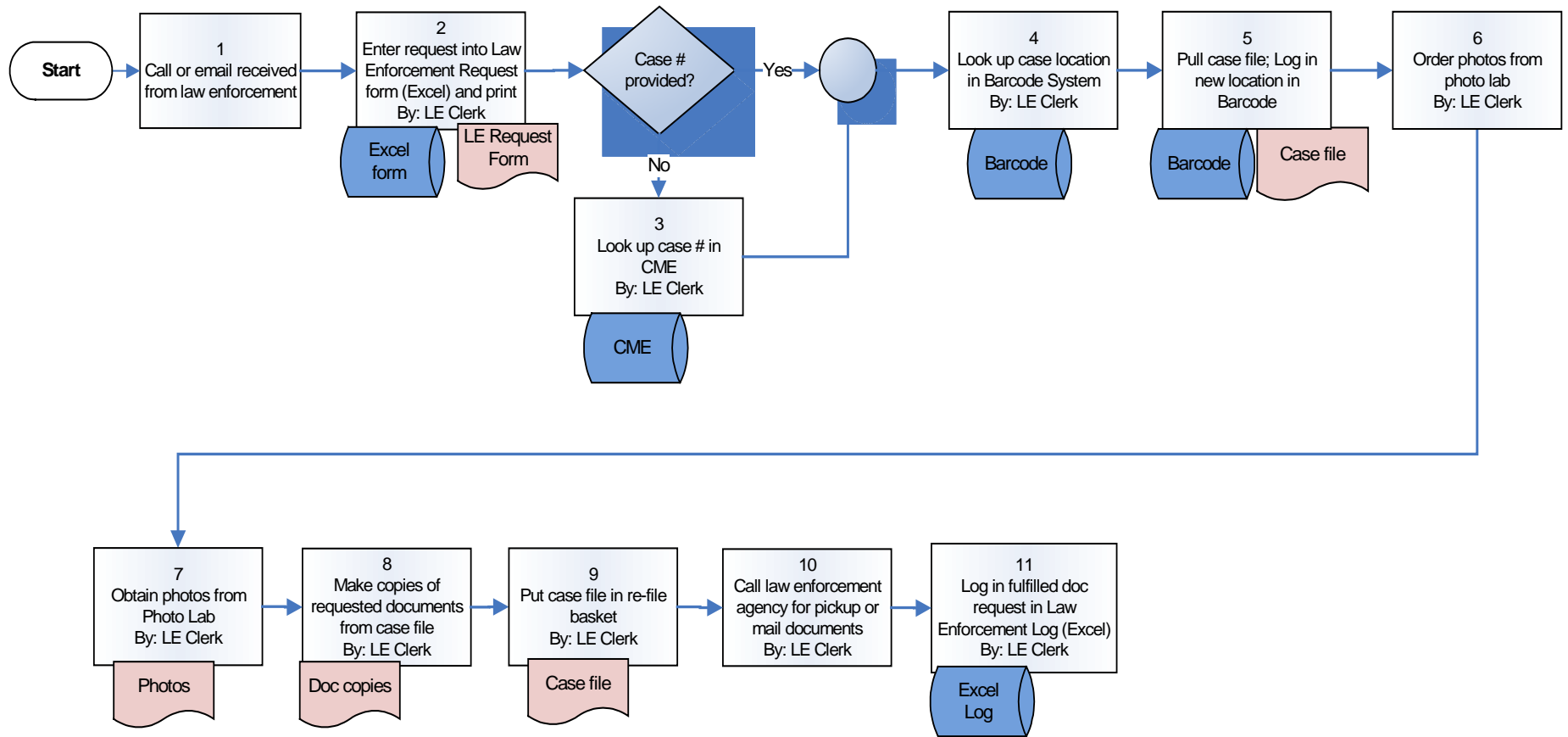

**Acronym Key**

CME = Coroner's Medical Examiner System  
 LE Clerk = Law Enforcement Clerk  
 LE Request Form = Law Enforcement Request Form

LA Coroner Mgmt Audit  
 Property Custodian  
 Page 1 of 1  
 Created 10/25/09  
 Edited

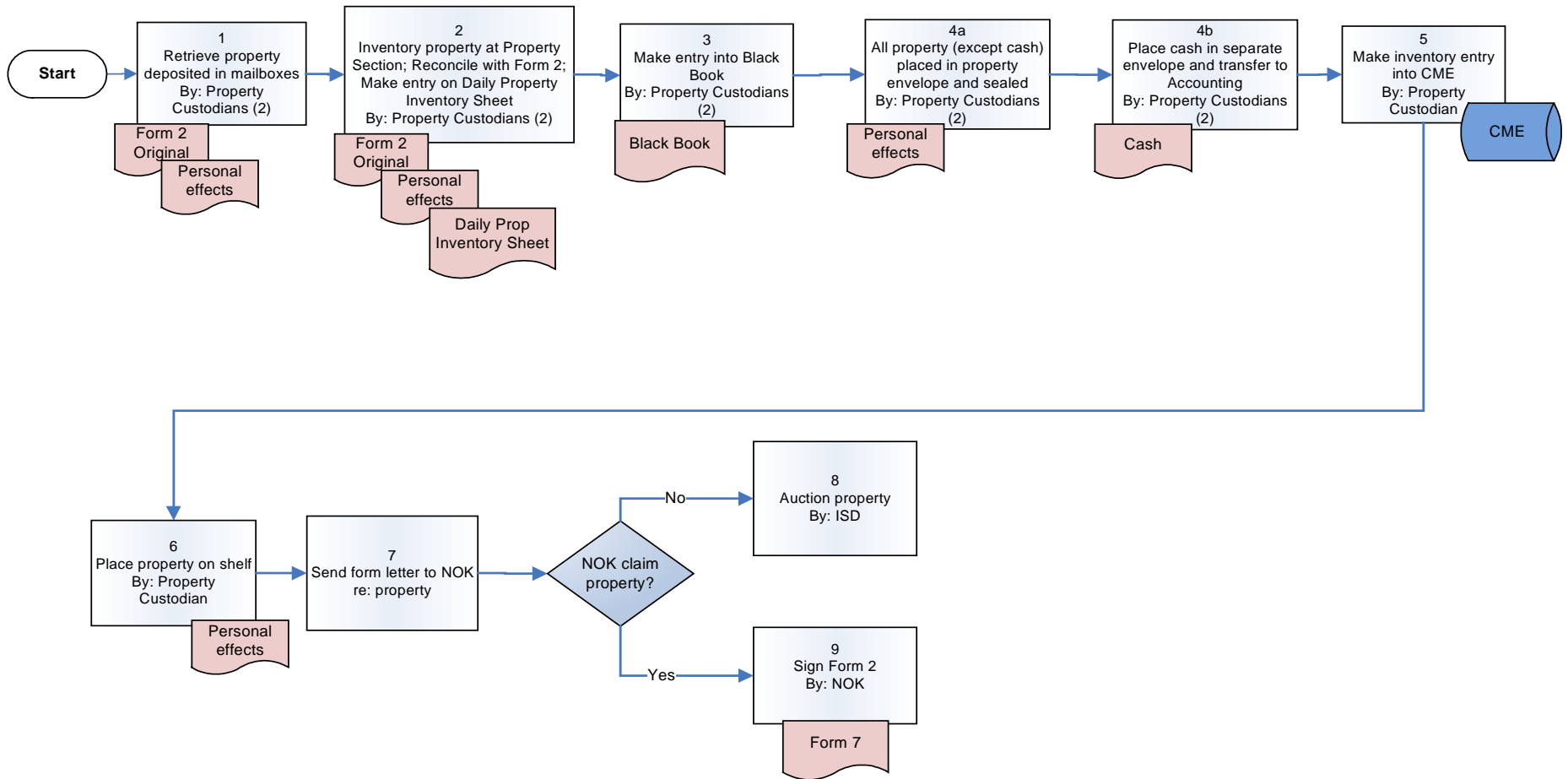

**Acronym Key**

CME = Coroner's Medical Examiner System  
 Form 2 = Personal Effects inventory  
 NOK = Next of Kin

**Appendix D – Benchmarking Charts**

Benchmark Comparisons

**Autopsies per Medical Examiner**

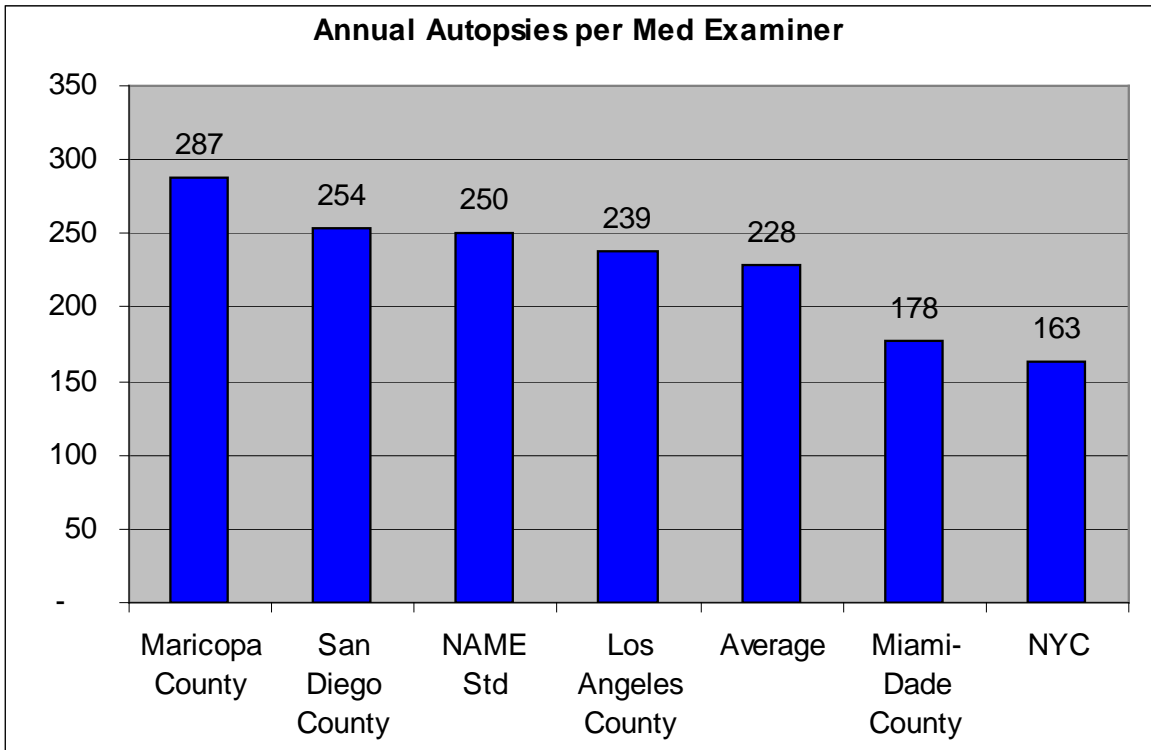

**Cases per Investigator**

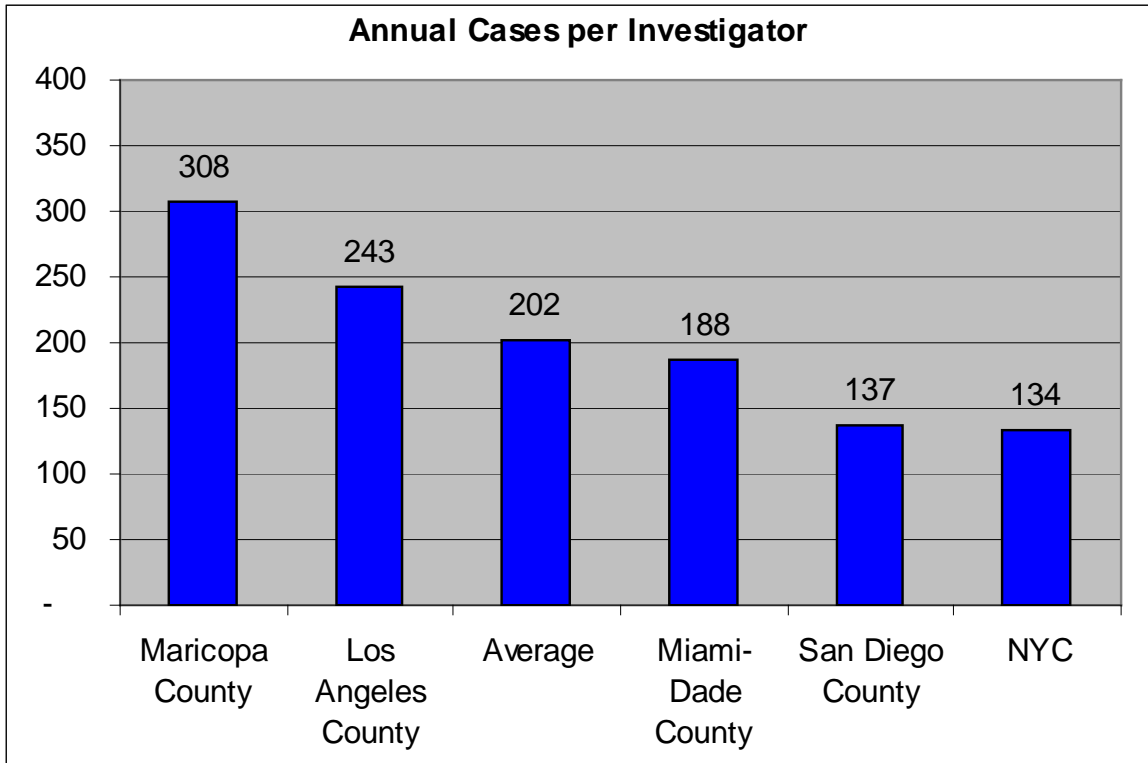

**Case Turnaround Times by County**

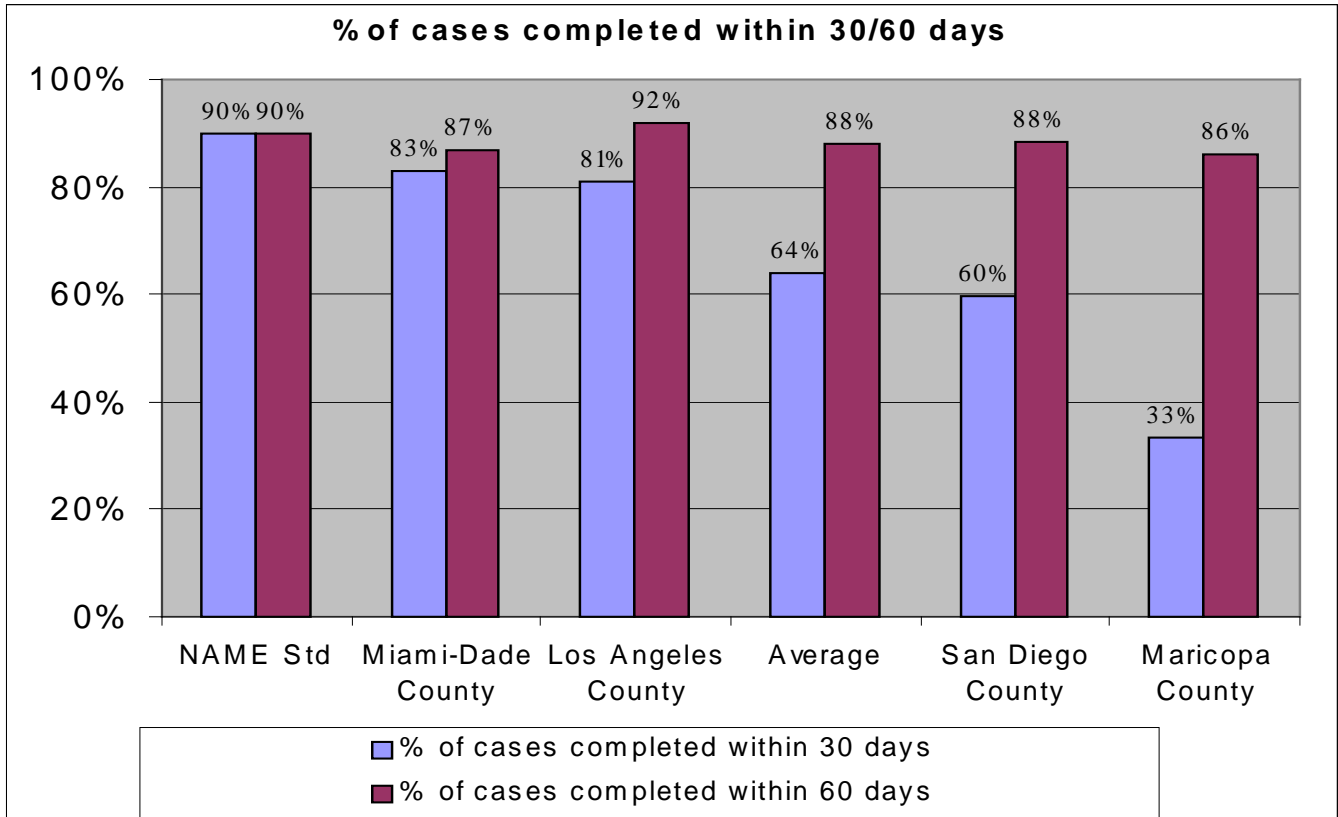

**Average Crypt Dwell Time**

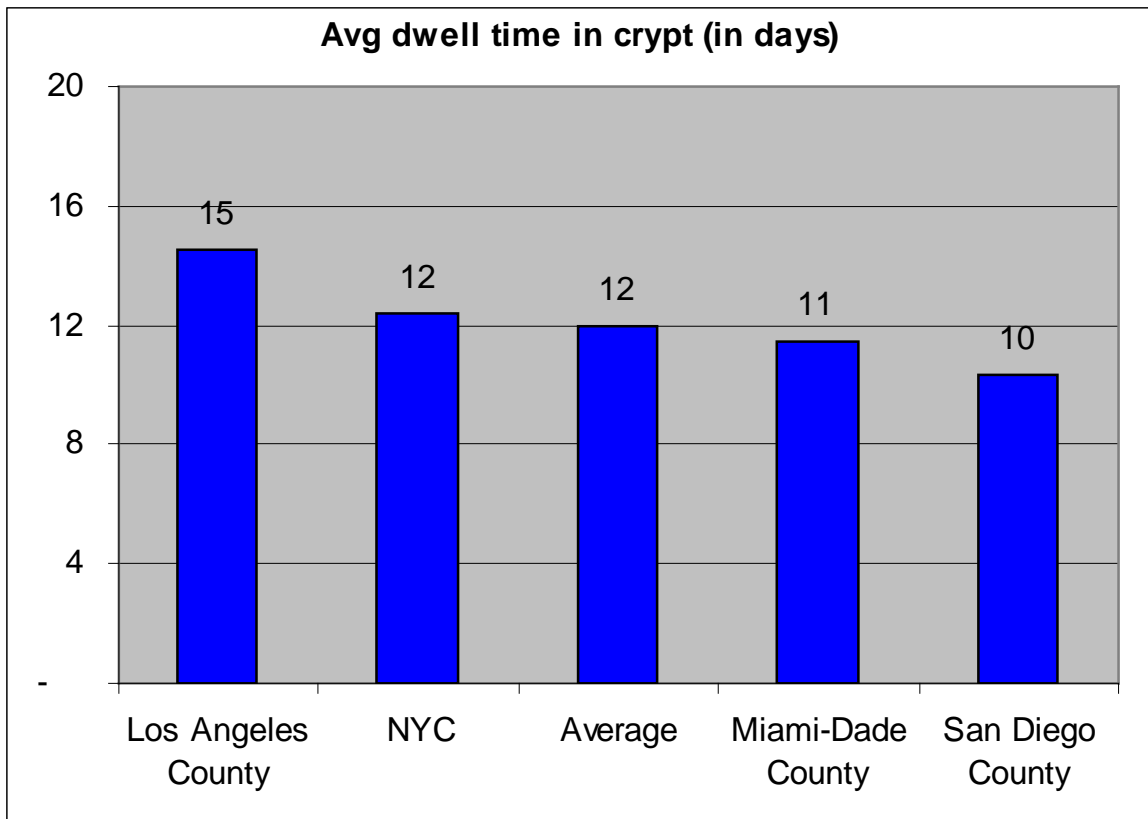



**Appendix E – Recommendation Table**

<b>Number</b>	<b>Recommendation</b>
A1	The Department of the Coroner should continue pursuing a Pathology Assistant training and residency program (e.g., with Rosalind Franklin University and the UCLA School of Medicine).
A2	The Department of the Coroner should work with the County Department of Human Resources to create a Pathology Assistant job classification and a competitive salary range.
A3	The Department of the Coroner should request an appropriation to fund the on-call forensic pathologist contracts for 2,000 hours per year beginning in FY 2010-11.
A4	The Department of the Coroner should appoint a mentoring director among the staff physicians and establish a code of conduct for physicians in dealing with physician postgraduates. Establish a resident mentorship program.
A5	The Department of the Coroner management should better communicate, monitor and enforce criteria for promotions, recognition, and assignments to ensure they are predictable and consistent.
A6	The Department of the Coroner should establish formal lines of communication beyond the existing chain of command structure with these two units to address issues, perceived or otherwise.

**MANAGEMENT AUDIT OF THE LOS ANGELES COUNTY CORONER**

Number	Recommendation
A7	The Department of the Coroner should revise its Take-Home Car policy to clearly define eligibility for participation, a finite time-line for participation (so that other Investigators have the opportunity to participate), and the expected on-call response rate. Additionally, a process for tracking and monitoring on-call response rates should be developed to ensure compliance with Department policy and strictly followed to ensure transparency.
B1	When the opportunity arises through retirement, the CEO/Board of Supervisors should consider consolidating the agency under a single chief executive position. Unifying command of the agency under a single position is inherently more efficient and eliminates the effect of personality on the effectiveness (or lack thereof) of the management structure.
B2	The Department of the Coroner should transfer the oversight responsibilities of the Forensic Photo and Support Division to the Chief Medical Examiner-Coroner.
C1	The Department of the Coroner should continue its efforts to implement workflow technologies using a case management system and the County's planned Documentum document management system to replace the reliance on paper case files and inefficient document preparation and transfer practices.
C2	The Department of the Coroner should test touchpad-based data collection tools (e.g., laptops or other field recording devices) for medical examiners and investigators.

**MANAGEMENT AUDIT OF THE LOS ANGELES COUNTY CORONER**

Number	Recommendation
C3	The Department of the Coroner should implement barcode labeling for all bodies, materials, specimens, samples and documents. If possible, it should use the Documentum system to produce labels based on case numbers generated in the case management system.
C4	The Department of the Coroner should replace the MS-Access-based Tox database with a toxicology lab module integrated into the case management system.
C5	The Department of the Coroner should continue its efforts to finalize the implementation of the Documentum platform and electronic case files. Once in place, the Coroner should continue its plan to implement a replacement Case Management System in Documentum.
C6	The CEO, in conjunction with the Coroner and DHS, should review the current DHS/Coroner processes and costs of handling the indigent dead to determine if appropriate resources, staffing, equipment, infrastructure (facilities, crematories) exist to adequately meet the needs of all County indigent decedent cases in a cost effective manner, whether the process complies with existing County ordinance, and whether other options such as outsourcing should be considered.
C7	The Department of the Coroner should scan all archived homicide cases that have not been disposed of (e.g., cold cases or not yet brought to trial), and cases from the previous five years starting with the most recent year.
C8	The Department of the Coroner should transfer management of lab PCs to ISD to ensure adequate back-up.

**MANAGEMENT AUDIT OF THE LOS ANGELES COUNTY CORONER**

Number	Recommendation
C9	The Department of the Coroner should use digital dictation equipment for recording medical exam observations. In the longer term, the department should phase out making corrections onto paper and begin correcting dictations directly onto MS-Word utilizing the track changes feature.
C10	The Department of the Coroner should use appropriate size jars for tissue sampling in accordance with standards set by the College of American Pathologists.
C11	The Department of the Coroner should enforce policies on wearing protective gear in the autopsy suites.
C12	The Department of the Coroner should implement routine quality control checks of Investigator evidence and property submissions by persons outside the Investigator chain of command. The Evidence Control Supervisor and the Property Supervisor could then meet with Investigations management to go over recent problem cases and suggest corrections.
C13	The Department of the Coroner should send generic letters to the next of kin 30 days after notification of death is first made, in addition to the courtesy letters that are sent months later if property has not been claimed. This initial notification letter should inform the next of kin regarding procedures for claiming property and retention and disposal policies.
C14	The Department of the Coroner should develop an equipment replacement plan for labs and autopsy areas.

**MANAGEMENT AUDIT OF THE LOS ANGELES COUNTY CORONER**

Number	Recommendation
D1	The Department of the Coroner and the CEO should consider modifying the renovation plan to include offices for all physicians that comply with County space standards published by the CEO if they have not yet been renovated.
D2	The Department of the Coroner should obtain approval from the CEO to modify the renovation plan to include renovation of the 1102 building, including new ceilings, floors, and furnishings.
E1	The Department of the Coroner should recalculate the GSR testing fee to ensure it accurately reflects actual costs on a per-test basis.
E2	The Department of the Coroner should pursue an amendment to County Code section 2.22.100 so that the actual expense incurred for transportation and handling can be recovered through fees.
E3	The Department of the Coroner should license the manufacture and sale of Skeletons merchandise to an outside firm and/or relocate to a high traffic area (preferably one with tourists). Combine with merchandise from other County and City agencies to reflect the colorful history of LA County government, one of the world's most fascinating urban areas.
E4	The Department of the Coroner should age accounts receivable on a monthly basis to identify those outstanding for over 30, 60 and 90 days and to ensure future services are not rendered (except those mandated by legal authority) until past due amounts are paid.
E5	The Department of the Coroner should require a retainer or payment up front for clients who demonstrate a history of non-payment or slow payment. This would apply primarily to law firms that pay for Coroner testimony.

**MANAGEMENT AUDIT OF THE LOS ANGELES COUNTY CORONER**

Number	Recommendation
E6	The Department of the Coroner should refer delinquent accounts (except for receivables from municipalities) to the TTC for collections per County Fiscal Manual Section 10.2.2 guidelines.
E7	The Department of the Coroner should work with the CEO to ensure that the DNA Lab Business Plan includes reasonable demand and financial projections, including financial viability to sustain the lab beyond the three-year timeline.
F1	The Department of the Coroner should enforce a strict ID badge policy for employees.
F2	The Department of the Coroner should install an up-to-date electronic card key access system in all buildings.
F3	The Department of the Coroner should hire custodial staff or contract with a provider of custodial service and eliminate the use of community service and work-release workers to perform custodial duties.
F4	The Department of the Coroner should judiciously monitor and document security incidents for a period of two years and analyze the findings to determine what, if any, additional security measures should be implemented to ensure a safe working environment for Coroner staff.
F5	The Department of the Coroner should obtain a qualified trainer to help modify the dog's temperament and evaluate and develop handling and care procedures (e.g., socialization, leash and boarding requirements, ect.). If incidents such as attacks and bites continue after the dog receives behavioral training, consider kenneling the dog at an offsite location during the day.

**MANAGEMENT AUDIT OF THE LOS ANGELES COUNTY CORONER**

---

Number	Recommendation
F6	As indicated in Recommendation C5, the Coroner should continue its plans to implement a replacement Case Management System in Documentum. In the interim, the Coroners should continue working with a private vendor to correct the Security Hold vulnerabilities in CME.
F7	As indicated in Recommendation C5, the Coroner should continue its plans to implement a replacement Case Management System in Documentum. In the interim, the Department of the Coroner should work with a private vendor to implement record-level security in CME so that only the author of a record can alter data.
F8	The Department of the Coroner should replace the MS-Access-based Tox database with a toxicology lab module that is integrated into the case management system.
G1	The Department of the Coroner should prioritize goals to allocate resources more effectively. Goals should be analyzed in terms of importance and ease and/or cost of implementation. For example, goals can be plotted on a graph to understand the trade-offs between importance and cost.
G2	The Department of the Coroner should prepare Action Plans for each goal, detailing timeframes and due dates, assigning accountability, describing standards, and defining specific measurements.
G3	The Department of the Coroner should track progress of plan implementation with detailed accountability at the appropriate management or supervisor levels below the bureau chief.

This page intentionally left blank.